

2023



LEAPERS[®], INC.

THE BEST NEVER REST



Third party trademarks may be used in this catalog for the convenience of customers to indicate the fit or compatibility of the applicable Leapers items.

COMPANY INTRODUCTION 004
 MILESTONES & MOMENTUM 004
 THE SOLUTION PROVIDER.....006
 PROVING GROUNDS 008
 BRANDS AND AMBASSADORS 010

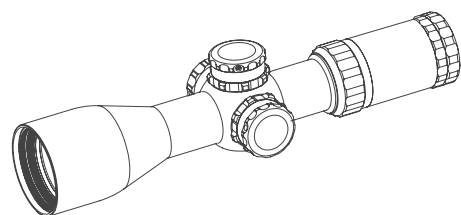

SCOPES 012
 INTEGRIX™ FFP SCOPES **[NEW]**..... 014
 iX8 LPVO / 1-8X28 018
 iX4 MID POWER / 3-12X50.....020
 iX6 MID POWER / 3-18X44 / 2-12X36 022
 iX6 LR/ELR / 4.5X27-56.....024
 ACCUSHOT PRO™ FFP SCOPES **[NEW]** 026
 AS6 LPVO / 1-6X24..... 030
 AS3 MID POWER / 3-9X36..... 032
 AS4 MID POWER / 3-12X44 034
 UTG® SFP SCOPES..... 036
 SCP3 SCOPES 040
 OP3 SCOPES 042
 BUG BUSTER® SCOPES 044
 TRUE HUNTER® SCOPES 046
 CROSSBOW SCOPES 048
 LONG EYE RELIEF SCOPES 050
 RETICLES..... 052
 SCOPE SPECIFICATIONS 054

DOT SIGHTS & MAGNIFIERS 056
 ACCU-SYNC™ DOT SIGHTS **[NEW]** 058
 UTG PRO® MRDS **[NEW]** 060
 OP3 MICRO MRDS 062
 ITA DOT SIGHTS 064
 3X FLIP-TO-SIDE MAGNIFIER..... 064

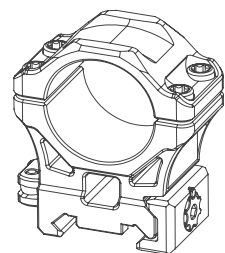
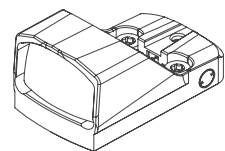

OPTIC MOUNTS & RINGS 066
 UTG PRO® P.O.I.® SCOPE RINGS 068
 ACCU-SYNC® QR SCOPE RINGS..... 070
 ACCU-SYNC® QR CANTILEVER MOUNTS 072
 CANTILEVER SCOPE RINGS & MOUNTS..... 073
 UTG® SCOPE RINGS & MOUNTS..... 074
 DOVETAIL-TO-PICATINNY MOUNTS..... 076
 DRILLED & TAPPED RECEIVER MOUNTS 076
 SHOTGUN SIDE SADDLE MOUNTS 077
 DEDICATED OPTIC MOUNTS 078
 FOR UTG® OP3 MICRO 079
 FOR TRIJICON® RMR..... 081
 FOR AIMPOINT® T1..... 081
 FOR TRIJICON® MRO..... 081
 AK RECEIVER MOUNTS 082
 PICATINNY RISERS..... 083

TABLE OF

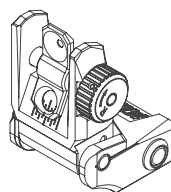

IRON SIGHTS 084
 UTG PRO® ULTRA LITE SIGHTS **[NEW]** 086
 UTG PRO® FLIP-UP SIGHTS 086
 SUPER SLIM FLIP-UP SIGHTS 088
 ACCU-SYNC® SPRING-LOADED FLIP-UP SIGHTS..... 088
 ACCU-SYNC® 45° FLIP-UP SIGHTS 088
 CARRY HANDLES..... 090
 SUPER SLIM FIXED SIGHTS..... 091

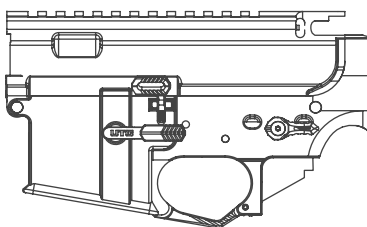

RECEIVERS 092
 UTG PRO® AR15 AMBI RECEIVERS **[NEW]** 096
 UTG PRO® AR15 RECEIVERS **[NEW]**..... 098

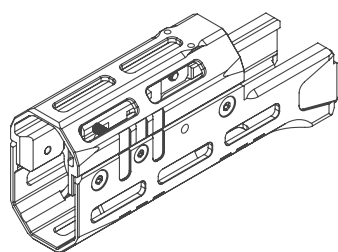

HANDGUARDS 100
 FORERUNNER FREE FLOAT 102
 ARWEN FREE FLOAT 104
 SUPER SLIM SD FREE FLOAT..... 106
 ULTRA SLIM FREE FLOAT..... 108

CONTENTS

SUPER SLIM FREE FLOAT 108
 AR15 DROP-IN 110
 AK DROP-IN..... 112
 RUGER PC CARBINE DROP-IN 113

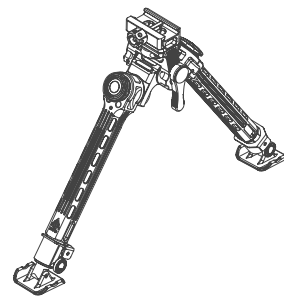

BIPODS 114
 UTG PRO® TBNR® BIPODS 116
 BIG BORE FULL STABILITY BIPOD 118
 OVER BORE BIPOD..... 120
 RECON FLEX® BIPODS 122
 RECON 360® TL BIPODS 124
 D GRIP® 126
 QUICK DETACH BIPODS 127

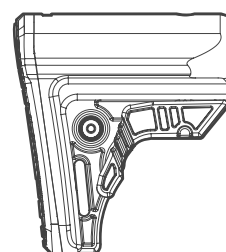

STOCKS, BUFFERS & TUBES 128
 AK SIDE FOLDER **[NEW]**..... 130
 AR15 COLLAPSIBLE STOCKS 132
 AR15 FIXED STOCKS 134
 AR308 FIXED STOCK..... 134
 TUBES & BUFFERS 136

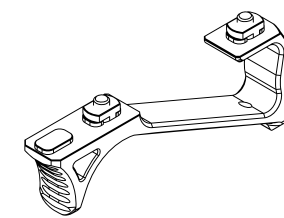

GRIPS & HAND STOPS 138
 PISTOL GRIPS..... 140
 VERTICAL GRIPS 141
 ULTRA SLIM ANGLED FOREGRIPS 142
 HAND STOPS..... 143

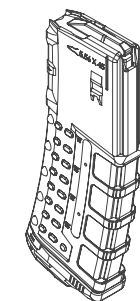

MAGAZINES 144
 AK/AKM POLYMER MAGAZINE **[NEW]** 146
 AR POLYMER MAGAZINES 148
 POLYMER MAGAZINES FOR GLOCK 150

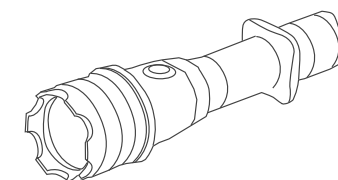

FLASHLIGHTS & LASERS 152
 HANDHELD LIGHTS 154
 WEAPON LIGHTS 155
 LASERS 156
 FLASHLIGHT & LASER ACCESSORIES 157

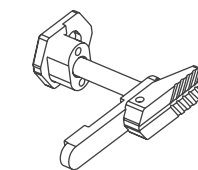

ACCESSORIES & TOOLS 158
 AR ACCESSORIES 160
 CZ SCORPION ACCESSORIES..... 161
 MUZZLE DEVICES & GAS BLOCKS..... 162
 QD SLING SWIVELS & ADAPTORS..... 163
 RAIL SECTIONS & COVERS 164
 TOOLS & MAINTENANCE 165

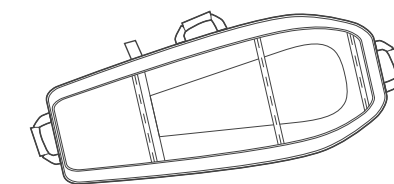

GUN CASES 166
 RAPID DEPLOYMENT PACKS 168
 RC CASE 170
 MC CASES 172
 DC CASES 174
 KEEP-IT-SIMPLE KIS CASES 176
 PISTOL CASES 178



TACTICAL GEAR 180
 TRAIL SEEKER, TRAIL CAM BACKPACK 182
 OVERBOUND PACK 184
 ALL-IN-ONE RANGE/UTILITY GO BAG..... 186
 HOLSTERS 188
 LONG GUN SLINGS & BELT..... 190
 TACTICAL VESTS 191



MILESTONES & MOMENTUM



1992 - 1997

- » Founded in Michigan, USA
- » Started Business in Garage
- » Made the First Sale of a Compact 4x28 Scope
- » 1st SHOT SHOW Presence

1998 - 2002

- » Expanded into Scopes, Rings, Mounts, Knives, Gun Cases, and Accessories
- » Started TRUE STRENGTH® Scope Platform
- » Moved into a 15,000 sqft Commercial Building in Livonia, Michigan

2003 - 2008

- » Established Multi-line & Vertical Integration Business Strategy
- » Established 1st Overseas Manufacturing Factory

2009 - 2013

- » Established UTG PRO® USA Manufacturing
- » Established UTG Europe Distribution Center in Germany

2014 - 2017

- » Expanded UTG PRO® USA Manufacturing to Include In-house CERAKOTE® and Injection Molding
- » Launched UTG World Class Wireless and Paperless Order Fulfillment Center

2018 - 2019

- » Established UTG Taiwan World Class Optics R&D and Manufacturing Center

2020 - 2021

- » Established Leapers Proving Grounds - 100 Yard Indoor Shooting Range
- » Initiated Premium INTEGRIX™ Optics Development

2022

- » Introduced INTEGRIX™ Premium Optics Brand
- » Manufactured 1st Billet AR Receiver in USA

OUR MISSION

The Best Never Rest

Leapers has outfitted shooters for more than 30 years. Most, if not all, have come across our well-established brands online, at a gun show, and or at their local gun shop down the street. Our mission is to promote a quality lifestyle through innovative and solution-oriented hunting and shooting sports optics and accessories with complete concept-to-delivery services to customers all over the world. Innovation, quality, value, and service are central to each and every one of our brands.



OUR COMMITMENT

Leaping into the Next 30 Years

Leapers was established in 1992. In the first 15 years, we focused on horizontal integration to bring multiple product lines into one umbrella for one-stop firearm accessory shopping. In the second 15 years, we strove to achieve vertical integration, ensuring that our products, from development, manufacturing to sales and service, are aligned and managed with our own complete control and discipline. Our commitment into the future is to fully leverage our synergized global organization with its R&D power and streamlined manufacturing and supply chain to keep bringing consumers "surprise and delight" products with superior technology contents that can be enjoyed in the great hunting and shooting sports.



SOLUTION PROVIDER

CONCEPT TO DELIVERY



Integrated Conceptual Design, Prototyping, and Validation

VALIDATION & LIFETIME WARRANTY



Product Endurance to Include Live-fire, Adverse Temperature, and Environmental Testing

CAPABLE MANUFACTURING



World-class CNC and Workcell Automation Executed to the Strictest Of Tolerances and Precision

WORLDWIDE REACH



Distributed and Partnered Worldwide to Reach Customers Across the Globe

ONE-STOP SHOPPING



The Go-to Optics and Shooting Sports Accessories Outfitter with over 700 Products

EXPERTS IN FULFILLMENT



Solution Driven and Long Term OEM, Dealer, Distributor, and Vendor Partnership Opportunities

MULTI-TIER BRANDING



Brands That Capture. Products that Deliver, Accessible to all and Serviced for Life

QUICK RESPONSE & SUPPORT

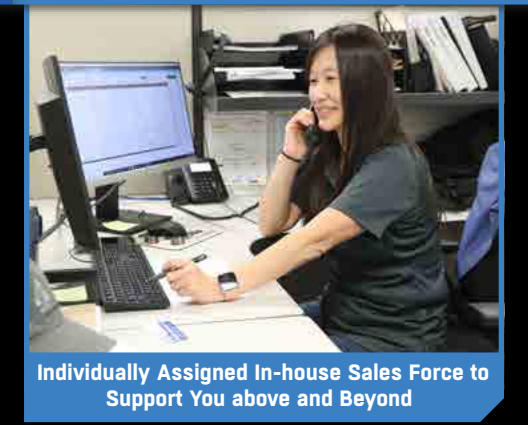

Individually Assigned In-house Sales Force to Support You above and Beyond

Shooter Driven and Proven

Does Not Expire, Does Not Tire, Serviced for Life Because The Best Never Rest

LEAPERS, INC.

TENR

THE BEST NEVER REST

- LIFETIME WARRANTY -

YOUR SATISFACTION IS OUR GOAL

Fanuc Roboshot Injection-Molding, Miyano 9 Axis, Mazak and Brother CNC, Zeiss CMM

100% Owned Manufacturing and Production Centers in US, Taiwan, and PRC

E-Commerce, Storefront, Gun Show, & 2-Step Distributor Ready

Accurate, Reliable, and Efficient Operation

Expertly Assembled and Packaged for Shooters to Kit Up and Go

Dedicated Customer Service Team is Ready to Assist and Standing by



PROVING GROUNDS

LIVE FIRE TESTING



Multiple Round Ransom Rest, Rapid and Slow Fire, and Bench Rest Testing

SOLVENT TESTING



Determines Material Limitations from Contact with Harsh and Common Chemicals

SIMULATED RECOIL SHOCK TESTING



Determines Max Shock Limitations Using Recoil Data Gathered from Multiple Calibers

ADVERSE TEMPERATURE TESTING



Determines Product Operational Ranges and Environmental Parameters

DROP & RACK TESTING



Repeated Drop Testing from Upwards of Two to Six Feet onto Different Surface Mediums

POI CONSISTENCY TESTING



Validates Point of Impact (POI) Standards throughout the Optic's Magnification Range

WATER & DUST INGRESS TESTING



Water and Dust Proof Testing to Ingress Protection (IP) Standards

FIELD TESTING



Validates Set Parameters for Product Operational Temperature Ranges

Product Caliber Rating Approval Testing and Validation



Ensures Product Reliability and Resilience when in Contact with Solvents



Ensures Caliber Rating and Endurance Numbers for Certain Products are Validated Accurately



Ensures Products Perform in Changing and Adverse Environments and Weather Conditions

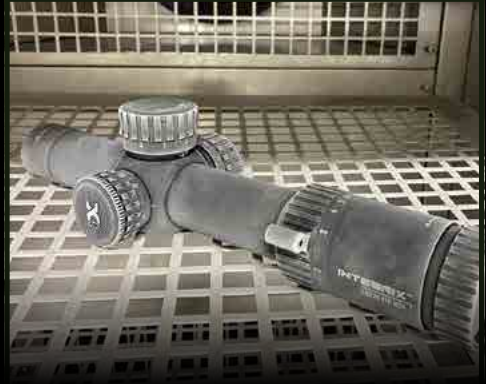

Reliability Tested by Deliberate and Repeated Slide Racks Directly Against our MRDS



Ensures POI Remains Consistent Incrementally Out to 1,000 Yards



Tested through Repetition to Ensure Continued Performance



Rapidly Confirms Designed Thresholds and Material Limitations for Product Consideration



BRANDS & AMBASSADORS



INTEGRIX

ACCUSHOT PRO

UTG PRO

UTG

MARTIN RICHTER - HOG HUNTER

JIM CHAPMAN - AIRGUN HUNTER

NICK TILL - MARKSMAN



A critical decision made often by shooters is what optic to pick for their firearms. It is a decision, one of integrity and intelligence to justify what we consider to be quality. The voice of the customer has spoken. Leapers has listened, and listened with decades of attention as well as persistent R&D. We have learned that quality optics achieve optimal performance only when superior optical design and mechanical precision integrate seamlessly under the strictest tolerance control. When such standards are met at the manufacturing level, our customers' dreams come true. Leapers brings to the forefront of shooters, the culmination of integrated and intelligent optical design and manufacturing. This is INTEGRIX™.



Mid-tier brand optics priced accordingly for shooters searching for the best value. Leveraging qualities from our premium INTEGRIX™ scopes and fully utilizing over 30 years of experience, this is our most well-rounded and balanced brand of scopes having optimized functionality, feature set, and build quality at a fair price. Every step from design, manufacturing, build assembly, through precision inspection and scenario testing embraces our "The Best Never Rest" motto, embracing our commitment to provide new product options with higher standards every year. Augmented optical performance, mechanical integrity and repeatability, and sleek functional aesthetics can all be had with ACCUSHOT PRO™.



Leapers started the UTG PRO® line of USA made products in 2009. Since then, products bearing the name have been well-established amongst the hunting and shooting-sports community as being quality Michigan-made parts and accessories. With a plethora of different products to choose from, our selection of handguards, stocks, magazines, bipods, and mounts are truly a one-stop shopping experience for the shooter looking to make their firearms better suited to their needs.



Leapers' grassroots brand comprising of a vast selection of optics, dot sights, mounts, scope rings, grips, and more. UTG® provides customers with solutions set out to be both affordable and complete. An essential collection and foundation that continues to pave the way for the new and experienced hunting and shooting sports enthusiast. The growing popularity and recognition of UTG® products continues to fuel Leapers' commitment to providing consumers with products that compete at every level.



With more than 25 years experience in the hunting and shooting industry, I expose my equipment to some of the harshest conditions in the field. From optics to firearm components and accessories, without a doubt, Leapers is second to none. That's why I choose Leapers products!



A lot of the game I hunt is in the low-light conditions of dawn and dusk, so an excellent light transmission characteristic is a key requirement for the scopes I use. The INTEGRIX™ scopes are really outstanding in this respect, providing clear images even in the last minutes of daylight!



I'm honored to partner with Leapers! Leapers and I share the same passion, to compete at the highest level with American made products (UTG PRO®) that are the best. Whether you are competing shooting or hunting you want to be the best! To be the best you need the best American made products (UTG PRO®) for your gun.

SCOPES

A NEW TRAJECTORY TOWARDS AUGMENTED ACCURACY.

Shooter driven feedback. The core principle of INTEGRIX™ and ACCUSHOT PRO™, two entirely new brands of optics for 2023. Leapers' brands for more than 30 years have been and continue to be proven and reliably called upon. Now that same dependable, sought after, and expected performance can be had and heightened by shooters of all disciplines and experience levels. Make your mark, augment your accuracy, and send it with an INTEGRIX™, ACCUSHOT PRO™, or UTG® scope.

JUMP TO A SERIES

	INTEGRIX™ FFP SCOPES [NEW]	014
	iX8 LPVO / 1-8X28	018
	iX4 Mid Power / 3-12X50	020
	iX6 Mid Power / 3-18X44 / 2-12X36	022
	iX6 LR/ELR / 4.5X27-56	024
	ACCUSHOT PRO™ FFP SCOPES [NEW]	026
	AS6 LPVO / 1-6X24	030
	AS3 Mid Power / 3-9X36	032
	AS4 Mid Power / 3-12X44	034
	UTG® SFP SCOPES	036
	SCP3 Scopes	040
	OP3 Scopes	042
	BUG BUSTER® Scopes	044
	TRUE HUNTER® Scopes	046
	CROSSBOW Scopes	048
	Long Eye Relief Scopes	050
	RETICLES	052
	SCOPE SPECIFICATIONS	054

(THIRD PARTY TRADEMARKS MAY BE USED IN THIS CATALOG FOR USER CONVENIENCE TO INDICATE THE FIT OR COMPATIBILITY OF THE APPLICABLE PRODUCT.)



INTEGRIX™



A critical decision made often by shooters is what optic to pick for their firearms. It is a decision, one of integrity and intelligence to justify what we consider to be quality.

The voice of the customer has spoken. Leapers has listened, and listened with decades of attention as well as persistent R&D. We have learned that quality optics achieve optimal performance only when superior optical design and mechanical precision integrate seamlessly under the strictest tolerance control. When such standards are met at the manufacturing level, our customers' dreams come true.

LEAPERS brings to the forefront of shooters, the culmination of integrated and intelligent optical design and manufacturing. **THIS IS INTEGRIX™.**

INTEGRIX™

THE CULMINATION OF INTEGRATED & INTELLIGENT OPTICAL DESIGN & MANUFACTURING.

INTEGRIX™ is pinnacle performance. Years of experience brought to the forefront through expert development and evaluation, countless testing, and meticulous manufacturing. German and Japanese glass lenses used exclusively in every INTEGRIX™ optic are individually centration tested, multi-coated for glare, reflection, and scratch resistance, and upon assembly are inspected for concentricity as a whole.

THE END RESULT? Low aberration optimized image quality with over a 92% light transmittance, edge-to-edge sharpness, minute distortion, and high contrast resolution.



END-TO-END CONSISTENCY

Optics Strictly Maintain a Smooth, Consistent, and Accurate Transition When Traversing Throughout its Magnification Range.

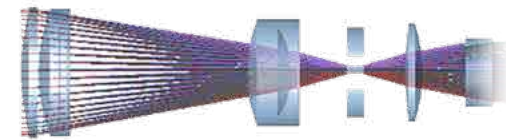

Expert Optical Design for Superior Performance
Optimum Light Transmittance of Over 92%
Consistent On-axis and Off-axis Image Quality



World-class Lenses & Coatings
SCHOTT (Germany) & OHARA (Japan) Glass
Tight Tolerance Control of Inner Lens Elements



A HIGHER BASELINE

Optics, at Minimum, are Rated for .338 Lapua Magnum.

A CRAFTED DIFFERENCE

Optics Feature an Erector Tube with a Precisely Manufactured Zoom Cam Curve for Consistently Tensioned, Smooth, and Accurate Adjustment.



CONTEST ANYWHERE

Optics Reliably Perform in Adverse Temperatures from -40° to 160° Fahrenheit and are IPX7 Rated.

HIGH DEFINITION

Quality German SCHOTT and Japanese OHARA Glass, Advanced 92% Light Transmittance, High Contrast Edge-to-edge Clarity, and Superior Wide-angle FOV Standard.



INTEGRIX™

IX⁸ 1-8X28 FFP A1 MOA RETICLE / 34 MM / iX801FA1



WWW.LEAPERS.COM | SINCE 1992

INTEGRIX™ iX8 1-8X28 FFP / LPVO **NEW**

- » Individually Centration Tested German and Japanese Glass, Concentric Tested Post Assembly
- » Multi-Coated Lenses for Glare, Reflection, and Scratch Resistance
- » Low Aberration Optimized Image Quality with Over a 92% Light Transmittance
- » Edge to Edge Sharpness, High Contrast, and High-Resolution Standard
- » Reliable Adverse Temperature and Environmental Performance with -40° to 160° Fahrenheit Operational Range and IPX7 Waterproof Rating
- » Rated, at Minimum, for .338 LAPUA Magnum
- » Red and Green Reticle Illumination with 10 Brightness Intensity Settings
- » 12 Hour Automatic Shutoff
- » Intuitive Lockable and Zero Resettable Windage and Elevation Turrets, Serrated and Oversized for Glove Use
- » Serrated Power Ring and Rear Adjustable Eyepiece Diopter
- » Make Transitioning Across Magnification Range Effortless with Included Oversized Throw Lever

ETCHED GLASS RANGE-ESTIMATING A1 MOA RETICLE

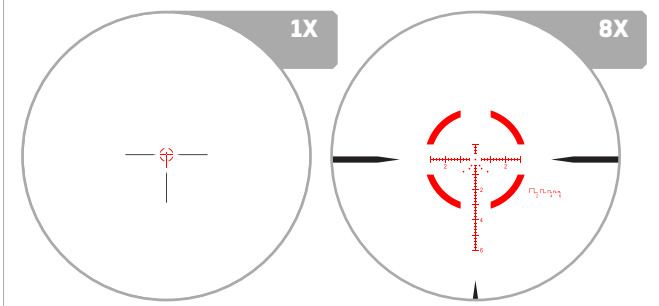

At 1X, a quick-to-acquire T-Dot enclosed within a 68 MOA segmented circle makes close up work, quick and to the point, functioning similarly to a dot sight. At higher magnifications the reticle opens up to provide users with a crisp 1 MOA center dot, range estimation out to 600 yards, and hash marks up to 60 MOA vertically for holdover and 30 MOA horizontally left and right in 2 MOA increments.

	iX801FA1
Focal Plane	FFP
Reticle	Etched Glass A1 MOA
Illumination	Red & Green, 10 Brightness Settings
Magnification	1X - 8X
Tube Diameter	34 mm
Objective Diameter	28 mm
Angular FOV	21.8° - 2.7°
Linear FOV @ 100 yds	115.5' - 14.1'
Linear FOV @ 100 m	38.5 m - 4.7 m
Elevation Travel	Up 60 MOA, Down 40 MOA
Windage Travel	Right 25 MOA, Left 25 MOA
Travel Per Revolution	50 MOA
Eye Relief	3.74" / 95 mm
Exit Pupil	10 mm - 3.5 mm
Diopter	-3D - +2D
Click Value	1/2 MOA
Parallax	Preset @ 100 yds / 91.4 m
Length	10.9" / 277 mm
Weight	25.3 oz / 716 g
Battery Type	CR2032





INTEGRIX™

IX⁴ 3-12X50 FFP A2 MOA RETICLE / 34 MM / iX403FA2



INTEGRIX™ iX4 3-12X50 FFP / MID POWER **NEW**

- » Individually Centration Tested German and Japanese Glass, Concentric Tested Post Assembly
- » Multi-Coated Lenses for Glare, Reflection, and Scratch Resistance
- » Low Aberration Optimized Image Quality with Over a 92% Light Transmittance
- » Edge to Edge Sharpness, High Contrast, and High-Resolution Standard
- » Reliable Adverse Temperature and Environmental Performance with -40° to 160° Fahrenheit Operational Range and IPX7 Waterproof Rating
- » Rated, at Minimum, for .338 LAPUA Magnum
- » Red and Green Reticle Illumination with 8 Brightness Intensity Settings
- » 12 Hour Automatic Shutoff
- » Side Adjustable Parallax Turret Smoothly and Accurately Adjusts from 30 Yards / 27.4 m to Infinity
- » Intuitive Lockable and Zero Resettable Windage and Elevation Turrets, Serrated and Oversized for Glove Use
- » Serrated Power Ring and Rear Adjustable Eyepiece Diopter
- » Make Transitioning Across Magnification Range Effortless with Included Oversized Throw Lever

ETCHED GLASS A2 MOA RETICLE

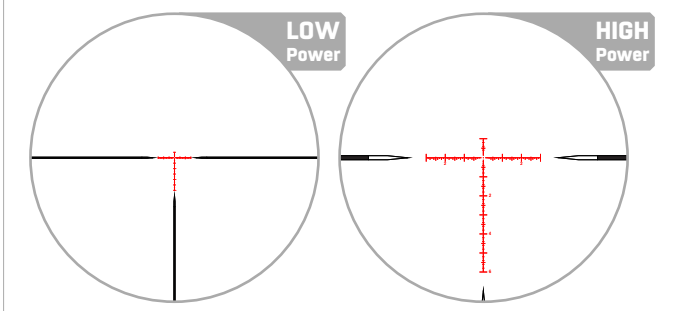

Clutter-free at both low and high magnifications to supplement overall FOV qualities, the German Duplex inspired A2 MOA reticle features sub-tensions that transition from being bolded to see-through while tapering down to a fine point towards the reticle's center. The center crosshair, at low magnification, provides a quick-to-acquire T-Dot and fully illuminates.

The T-Dot at higher magnification opens up and provides an unobtrusive 0.5 MOA floating center dot which focuses the eyes to the center of the reticle and frees up space between it and the remainder of the reticle to provide a better view of critical target details. The reticle spans 10 MOA up and 60 MOA down and 30 MOA left and right in 1 MOA increments.

	iX403FA2
Focal Plane	FFP
Reticle	Etched Glass A2 MOA
Illumination	Red & Green, 8 Brightness Settings
Magnification	3X - 12X
Tube Diameter	34 mm
Objective Diameter	50 mm
Angular FOV	7.2° - 1.8°
Linear FOV @ 100 yds	37.7' - 9.4'
Linear FOV @ 100 m	12.6 m - 3.1 m
Elevation Travel	Up 60 MOA, Down 30 MOA
Windage Travel	Right 12 MOA, Left 12 MOA
Travel Per Revolution	24 MOA
Eye Relief	3.94" / 100 mm
Exit Pupil	13 mm - 4.5 mm
Diopter	-3D - +2D
Click Value	1/4 MOA
Parallax	30 yds / 27.4 m - ∞
Length	11.7" / 297 mm
Weight	29.7 oz / 842 g
Battery Type	CR2032



INTEGRIX™



2-12X36 FFP
A2 MOA RETICLE / 34 MM / iX602FA2

3-18X44 FFP
A2 MOA RETICLE / 34 MM / iX603FA2



2-12X36 FFP
A2 MOA RETICLE / 34 MM / iX602FA2



3-18X44 FFP
A2 MOA RETICLE / 34 MM / iX603FA2



INTEGRIX™ IX6 2-12X36 FFP / 3-18X44 FFP / MID POWER **NEW**

- » Individually Centration Tested German and Japanese Glass, Concentric Tested Post Assembly
- » Multi-Coated Lenses for Glare, Reflection, and Scratch Resistance
- » Low Aberration Optimized Image Quality with Over a 92% Light Transmittance
- » Edge to Edge Sharpness, High Contrast, and High-Resolution Standard
- » Reliable Adverse Temperature and Environmental Performance with -40° to 160° Fahrenheit Operational Range and IPX7 Waterproof Rating
- » Rated, at Minimum, for .338 LAPUA Magnum
- » Red and Green Reticle Illumination with 8 Brightness Intensity Settings
- » 12 Hour Automatic Shutoff
- » Side Adjustable Parallax Turret Smoothly and Accurately Adjusts from 30 Yards / 27.4 m to Infinity
- » Intuitive Lockable and Zero Resettable Windage and Elevation Turrets, Serrated and Oversized for Glove Use
- » Serrated Power Ring and Rear Adjustable Eyepiece Diopter
- » Make Transitioning Across Magnification Range Effortless with Included Oversized Throw Lever

ETCHED GLASS A2 MOA RETICLE

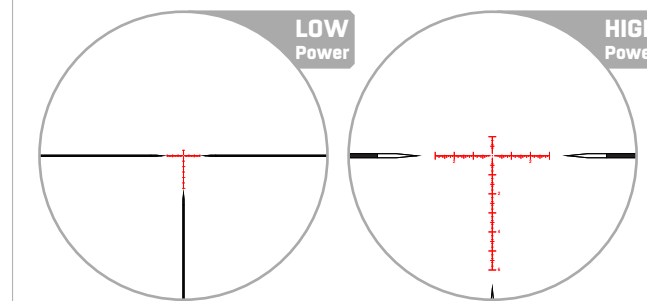

Clutter-free at both low and high magnifications to supplement overall FOV qualities, the German Duplex inspired A2 MOA reticle features sub-tensions that transition from being bolded to see-through while tapering down to a fine point towards the reticle's center. The center crosshair, at low magnification, provides a quick-to-acquire T-Dot and fully illuminates.

The T-Dot at higher magnification opens up and provides an unobtrusive 0.5 MOA floating center dot which focuses the eyes to the center of the reticle and frees up space between it and the remainder of the reticle to provide a better view of critical target details. The reticle spans 10 MOA up and 60 MOA down and 30 MOA left and right in 1 MOA increments.

	IX602FA2	IX603FA2
Focal Plane	FFP	FFP
Reticle	Etched Glass A2 MOA	
Illumination	Red & Green, 8 Brightness Settings	
Magnification	2X - 12X	3X - 18X
Tube Diameter	34 mm	34 mm
Objective Diameter	36 mm	44 mm
Angular FOV	10.9° - 1.8°	7.2° - 1.2°
Linear FOV @ 100 yds	57.2' - 9.4'	37.7' - 6.3'
Linear FOV @ 100 m	19.1 m - 3.1 m	12.6 m - 2.1 m
Elevation Travel	Up 60 MOA, Down 30 MOA	
Windage Travel	Right 12 MOA, Left 12 MOA	
Travel Per Revolution	24 MOA	24 MOA
Eye Relief	3.94" / 100 mm	3.94" / 100 mm
Exit Pupil	10 mm - 3 mm	11 mm - 2.5 mm
Diopter	-3D - +2D	-3D - +2D
Click Value	1/4 MOA	1/4 MOA
Parallax	10 yds / 9 m - ∞	30 yds / 27.4 m - ∞
Length	10.7" / 273 mm	11.7" / 297 mm
Weight	28.2 oz / 800 g	28.6 oz / 811 g
Battery Type	CR2032	CR2032



INTEGRIX™



4.5-27X56 FFP MRAD RETICLES / 34 MM

- M1 MRAD RETICLE / iX645FM1
- M2 MRAD RETICLE / iX645FM2
- M3 MRAD RETICLE / iX645FM3



WWW.LEAPERS.COM | SINCE 1992

INTEGRIX™ iX6 4.5-27X56 FFP / LR/ELR **NEW**

- » Individually Centration Tested German and Japanese Glass, Concentric Tested Post Assembly
- » Multi-Coated Lenses for Glare, Reflection, and Scratch Resistance
- » Low Aberration Optimized Image Quality with Over a 92% Light Transmittance
- » Edge to Edge Sharpness, High Contrast, and High-Resolution Standard
- » Reliable Adverse Temperature and Environmental Performance with -40° to 160° Fahrenheit Operational Range and IPX7 Waterproof Rating
- » Rated, at Minimum, for .338 LAPUA Magnum
- » Red and Green Reticle Illumination with 8 Brightness Intensity Settings
- » 12 Hour Automatic Shutoff
- » Side Adjustable Parallax Turret Smoothly and Accurately Adjusts from 30 Yards / 27.4 m to Infinity
- » Intuitive Lockable and Zero Resettable Windage and Elevation Turrets, Serrated and Oversized for Glove Use
- » Serrated Power Ring and Rear Adjustable Eyepiece Diopter
- » Make Transitioning Across Magnification Range Effortless with Included Oversized Throw Lever

ETCHED GLASS M1 / M2 / M3 MRAD RETICLES (* Refer to P. 052 for More Info.)

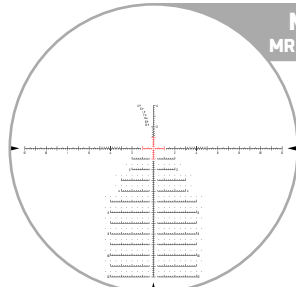

**M1
MRAD**

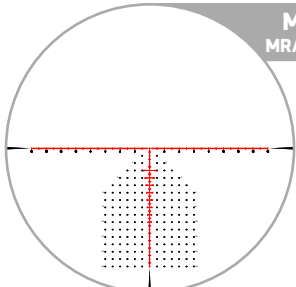

**M2
MRAD**

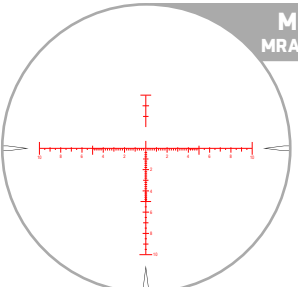

**M3
MRAD**

	iX645FM1	iX645FM2	iX645FM3
Focal Plane	FFP		
Reticle	Etched Glass M1 MRAD	Etched Glass M2 MRAD	Etched Glass M3 MRAD
Illumination	Red & Green, 8 Brightness Settings		
Magnification	4.5X - 27X		
Tube Diameter	34 mm		
Objective Diameter	56 mm		
Angular FOV	4.8° - 0.8°		
Linear FOV @ 100 yds	25.1' - 4.2'		
Linear FOV @ 100 m	8.4 m - 1.4 m		
Elevation Travel	Up 16 MRAD		
Windage Travel	Right 4 MRAD, Left 4 MRAD		
Travel Per Revolution	8 MRAD		
Eye Relief	3.94" / 100 mm		
Exit Pupil	11 mm - 2.1 mm		
Diopter	-3D - +2D		
Click Value	0.1 MRAD		
Parallax	30 yds / 27.4 m - ∞		
Length	14" / 355 mm		
Weight	35.1 oz / 996 g		
Battery Type	CR2032		



ACCUSHOT PRO™

Mid-tier brand optics priced accordingly for shooters searching for the best value. Leveraging qualities from our premium INTEGRIX™ scopes and fully utilizing over 30 years of experience, this is our most well-rounded and balanced brand of scopes having optimized functionality, feature set, and build quality at a fair price.

Every step from design, manufacturing, build assembly, through precision inspection and scenario testing embraces our “the best never rest” motto, embracing our commitment to provide new product options with higher standards every year. Augmented optical performance, mechanical integrity and repeatability, and sleek functional aesthetics can all be had with **ACCUSHOT PRO™**.



ACCUSHOT PRO™

ALL-AROUND PERFORMANCE

Mid-tier brand optics priced accordingly and leveraging qualities from our premium INTEGRIX™ scopes. Fully utilizing over 30 years of experience, this is our most balanced scope brand having optimized shooter driven functionality, feature set, and build quality at a fair price.

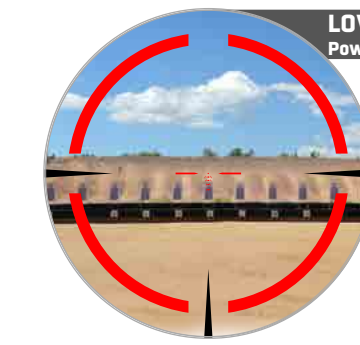

LOW Power

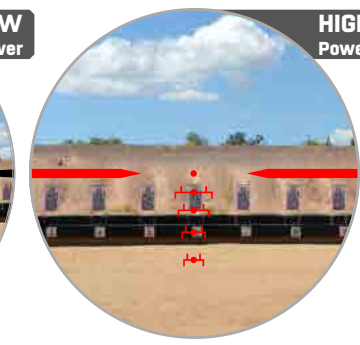

HIGH Power

First Focal Plane and HD Image Quality

Consistent Reticle Scaling That Is Proportionate At All Magnifications For Ease Of Ranging and Holding Over with Edge to Edge Clarity

Durable One-piece Construction

Solid Block of Aluminum CNC Machined for Rigidity



Dynamic Live Fire Testing

Field Tested for Specific Applications and Professional Qualification



BALANCE PERFECTED

First Focal Plane Scopes Leveraging Similar iX™ Advantages at a More Moderate and Accessible Price.

QUICK ACQUIRE ADJUSTMENT

Side Parallax Adjustment, Low Profile Quick-turn Locking W/E Turrets, and Serrated Power Ring with Optional Throw Lever Included.

OPTIMIZED CLARITY

90% Light Transmittance for Vivid Viewfinder Clarity with Sharp-focus Glass-etched Reticle Options.

DUAL-ILLUMINATION

Red & Green Daylight-bright Illumination Standard with 12 Hour Automatic Shutoff.



ACCUSHOT PRO™



1-6X24 FFP
BDC RETICLE / MOA RETICLE / 34 MM

B1 BDC RETICLE / AS601FB1
A1 MOA RETICLE / AS601FA1



ACCUSHOT PRO™

AS6 1-6X24 FFP / LPVO NEW

- » Multi-coated Lenses for Optimized Image Quality
- » Sharp 90% Light Transmittance with High Definition Clarity and Contrast
- » Quick-to-acquire Etched-glass Range Estimating B1 (5.56 BDC) Reticle
- » Reliable Adverse Temperature and Environmental Performance with -40° to 160°F Operational Range and IPX7 Waterproof Rating
- » Red and Green Reticle Illumination with 10 Brightness Intensity Settings
- » 5,000+ Hours Battery Life with 12 Hour Automatic Shutoff
- » Serrated Flat Profile Lockable and Zero Resettable W/E Turrets
- » Serrated Adjustable Eyepiece Diopter and Power Ring
- » Includes Optional Oversized Power Ring Throw Lever and Flip Open Lens Caps

ETCHED GLASS B1 BDC RETICLE / A1 MOA RETICLE (* Refer to P. 052 - P. 053 for More Info.)

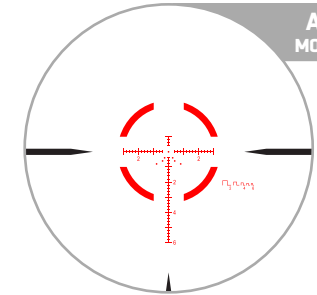
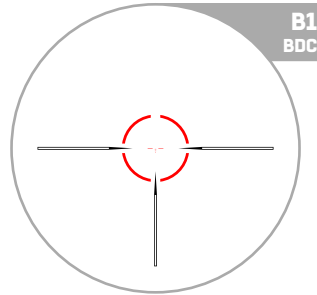

	AS601FB1	AS601FA1
Focal Plane	FFP	
Reticle	Etched Glass B1 BDC	Etched Glass A1 MOA
Illumination	Red & Green, 10 Brightness Settings	
Magnification	1X - 6X	
Tube Diameter	34 mm	
Objective Diameter	24 mm	
Angular FOV	21.8° - 3.6°	
Linear FOV @ 100 yds	115.5' - 18.9'	
Linear FOV @ 100 m	38.5 m - 6.3 m	
Elevation Travel	Up 60 MOA, Down 40 MOA	
Windage Travel	Right 24 MOA, Left 24 MOA	
Travel Per Revolution	48 MOA	
Eye Relief	3.54" / 90 mm	
Exit Pupil	9.5 mm - 4.0 mm	
Diopter	-3D - +2D	
Click Value	1/2 MOA	
Parallax	Preset @ 100 yds / 91.4 m	
Length	10" / 255 mm	
Weight	24.4 oz / 691 g	
Battery Type	CR2032	



ACCUSHOT PRO™



VAS3 3-9X36 FFP A2 MOA RETICLE / 34 MM / AS303FA2



ACCUSHOT PRO™ AS3 3-9X36 FFP / MID POWER **NEW**

- » Multi-coated Lenses for Optimized Image Quality
- » Sharp 90% Light Transmittance with High Definition Clarity and Contrast
- » Clutter-free German Duplex Inspired Etched-glass MOA Illuminated Reticle
- » Reliable Adverse Temperature and Environmental Performance with -40° to 160°F Operational Range and IPX7 Waterproof Rating
- » Red and Green Reticle Illumination with 8 Brightness Intensity Settings
- » 800+ Hours Battery Life with 12 Hour Automatic Shutoff
- » Uniquely Compact for its Magnification Class with Serrated Flat Profile Lockable and Zero Resettable W/E Turrets
- » Serrated Adjustable Eyepiece Diopter and Power Ring
- » Includes Optional Oversized Power Ring Throw Lever and Flip Open Lens Caps

ETCHED GLASS A2 MOA RETICLE

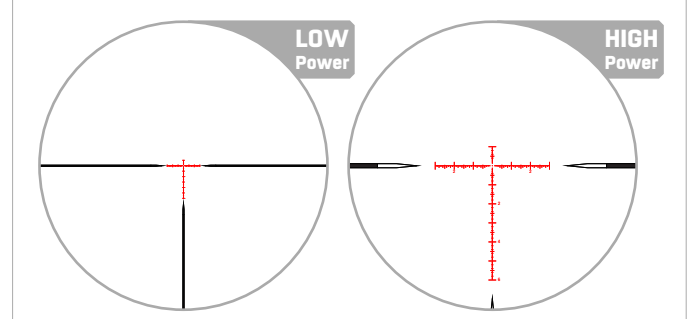

Clutter-free at both low and high magnifications to supplement overall FOV qualities, the German Duplex inspired A2 MOA reticle features sub-tensions that transition from being bolded to see-through while tapering down to a fine point towards the reticle's center. The center crosshair, at low magnification, provides a quick-to-acquire T-Dot and fully illuminates.

The T-Dot at higher magnification opens up and provides an unobtrusive 0.5 MOA floating center dot which focuses the eyes to the center of the reticle and frees up space between it and the remainder of the reticle to provide a better view of critical target details. The reticle spans 10 MOA up and 60 MOA down and 30 MOA left and right in 1 MOA increments.

	AS303FA2
Focal Plane	FFP
Reticle	Etched Glass A2 MOA
Illumination	Red & Green, 8 Brightness Settings
Magnification	3X - 9X
Tube Diameter	30 mm
Objective Diameter	36 mm
Angular FOV	6.4° - 2.2°
Linear FOV @ 100 yds	33.5' - 11.5'
Linear FOV @ 100 m	11.2 m - 3.8 m
Elevation Travel	Up 60 MOA, Down 40 MOA
Windage Travel	Right 9 MOA, Left 9 MOA
Travel Per Revolution	18 MOA
Eye Relief	3.54" / 90 mm
Exit Pupil	10.5 mm - 4.0 mm
Diopter	-3D - +2D
Click Value	1/4 MOA
Parallax	10 yds / 9.14 m - ∞
Length	8.5" / 215 mm
Weight	15 oz / 425 g
Battery Type	CR2032

ACCUSHOT PRO™



AS4 3-12X44 FFP A2 MOA RETICLE / 34 MM / AS403FA2



ACCUSHOT PRO™ AS4 3-12X44 FFP / MID POWER **NEW**

- » Multi-coated Lenses for Optimized Image Quality
- » Sharp 90% Light Transmittance with High Definition Clarity and Contrast
- » Clutter-free German Duplex Inspired Etched-glass MOA Illuminated Reticle
- » Reliable Adverse Temperature and Environmental Performance with -40° to 160°F Operational Range and IPX7 Waterproof Rating
- » Red and Green Reticle Illumination with 8 Brightness Intensity Settings
- » 800+ Hours Battery Life with 12 Hour Automatic Shutoff
- » Lockable and Zero Resettable W/E Turrets with Revolution Indicator along Elevation Turret, Serrated and Oversized for Gloved Use
- » Serrated Adjustable Eyepiece Diopter and Power Ring
- » Includes Optional Oversized Power Ring Throw Lever and Flip-open Lens Caps

ETCHED GLASS A2 MOA RETICLE

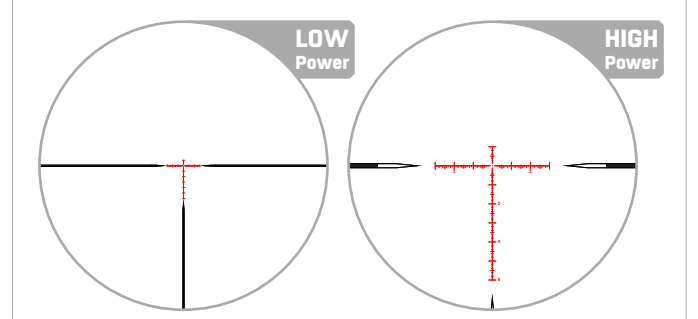

Clutter-free at both low and high magnifications to supplement overall FOV qualities, the German Duplex inspired A2 MOA reticle features sub-tensions that transition from being bolded to see-through while tapering down to a fine point towards the reticle's center. The center crosshair, at low magnification, provides a quick-to-acquire T-Dot and fully illuminates.

The T-Dot at higher magnification opens up and provides an unobtrusive 0.5 MOA floating center dot which focuses the eyes to the center of the reticle and frees up space between it and the remainder of the reticle to provide a better view of critical target details. The reticle spans 10 MOA up and 60 MOA down and 30 MOA left and right in 1 MOA increments.

	AS403FA2
Focal Plane	FFP
Reticle	Etched Glass A2 MOA
Illumination	Red & Green, 8 Brightness Settings
Magnification	3X - 12X
Tube Diameter	34 mm
Objective Diameter	44 mm
Angular FOV	7.2° - 1.8°
Linear FOV @ 100 yds	37.7' - 9.4'
Linear FOV @ 100 m	12.6 m - 3.1 m
Elevation Travel	Up 60 MOA, Down 40 MOA
Windage Travel	Right 11 MOA, Left 11 MOA
Travel Per Revolution	22 MOA
Eye Relief	3.54" / 90 mm
Exit Pupil	11 mm - 3.7 mm
Diopter	-3D - +2D
Click Value	1/4 MOA
Parallax	25 yds / 22.9 m - ∞
Length	11.4" / 289 mm
Weight	28.6 oz / 767 g
Battery Type	CR2032



Our grassroots brand that has been a constant in the marketplace and in the hands of shooting enthusiasts since our establishment over 30 years ago. From the days of plinking with our first 10/22 to the present, UTG® scopes have been a common go-to for affordable hunting and shooting sports optics that deliver complete solutions out-of-the-box.

Known by many of our customers, the proven TRUE STRENGTH® platform, an advanced sealed recoil system at the core of every UTG® scope, provides legendary shockproof, fogproof, and rainproof performance. Shooters who find value in application-specific features, but within a large variety to choose from look to UTG®, an essential collection and foundation that continues to pave the way for the new and the experienced.



AN ARRAY OF OPTIONS

1" and 30mm Offerings with Models and Reticles Catered to Close, Mid, and Long Ranges.

COMPLETE SOLUTIONS

Ready to Install Out-of-the-box with the Majority of Models Coming Included with Scope Rings, Lens Caps, and More.



MULTIPLE APPLICATIONS

Something for Everyone to Include Specialized Crossbow, Pistol, and Long Eye Relief Scopes.

BACKED FOR LIFE

Take with You Peace of Mind with a Lifetime Warranty that Delivers.

UTG®

HERITAGE SINCE 1992

Leapers' grassroots optics brand. **UTG®** scopes provide customers with solutions set out to be both affordable and complete. An essential collection and foundation that continues to pave the way for new and experienced hunting and shooting sports enthusiasts alike.

TRUE STRENGTH® PLATFORM

Strengthened Inner to Outer Tube Interface Reinforces W/E Turret Response, Precision, and Resistance to Recoil for Shock, Rain, and Fog Proof Performance



EZ-TAP® ILLUMINATION ENHANCED

Accommodate Environment, Light, and Weather Conditions with Red & Green Dual Color and 36 Multi-color Illumination Modes Standard on Most Models

EMERALD LENS COATINGS

Reduced Reflection and Balanced Light Transmission for Optimized Clarity



UTG® SCP3 SCOPES

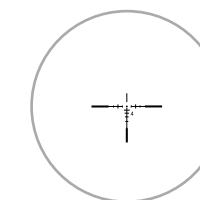

1-8X28 / SFP / 30 MM
ETCHED GLASS BG4 / IE® 36-COLOR
 / SCP3-18IEBG4

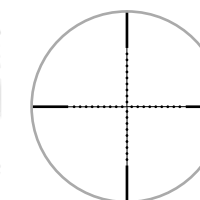

3-12X44 / SFP / 30 MM
WIRE MIL-DOT / IE® 36-COLOR
 / SCP3-U312AOIEW
 / SCP3-UM312AOIEW

4-16X44 / SFP / 30 MM
WIRE MIL-DOT / IE® 36-COLOR
 / SCP3-U416AOIEW
 / SCP3-UM416AOIEW

US PAT. 8437079
 EU PAT. EP2520894



	SCP3-18IEBG4	SCP3-U312AOIEW	SCP3-UM312AOIEW	SCP3-U416AOIEW	SCP3-UM416AOIEW
Focal Plane	SFP	SFP	SFP	SFP	SFP
Reticle	Etched Glass BG4	Wire Mil-Dot	Wire Mil-Dot	Wire Mil-Dot	Wire Mil-Dot
Illumination	IE® 36-Color	IE® 36-Color	IE® 36-Color	IE® 36-Color	IE® 36-Color
Magnification	1X - 8X	3X - 12X	3X - 12X	4X - 16X	4X - 16X
Tube Diameter	30 mm	30 mm	30 mm	30 mm	30 mm
Objective Diameter	28 mm	44 mm	44 mm	44 mm	44 mm
Angular FOV	18.8° - 2.5°	6.5° - 1.6°	6.1° - 1.9°	4.7° - 1.3°	5° - 1.5°
Linear FOV @ 100 yds	99.5' - 13.0'	34.0' - 8.5'	32.0' - 10.0'	24.4' - 6.8'	26.2' - 7.85'
Eye Relief	5" - 3.35" / 127 mm - 85 mm	3.3" - 3.0" / 84 mm - 76 mm	3.4" - 3.0" / 86 mm - 76 mm	3.2" - 3.0" / 81 mm - 76 mm	3.4" - 3.0" / 86 mm - 76 mm
Exit Pupil	26.5 mm - 3.4 mm	13.1 mm - 3.7 mm	13.0 mm - 3.9 mm	10.2 mm - 2.8 mm	11.0 mm - 2.7 mm
Diopter	-2D - +2D	-2D - +2D	-2D - +2D	-2D - +2D	-2D - +2D
Click Value	1/2"	1/4"	1/4"	1/4"	1/4"
Parallax	Preset @ 100 yds	10 yds - ∞	10 yds - ∞	10 yds - ∞	10 yds - ∞
Length	10.2" / 259 mm	14.0" / 356 mm	11.1" / 282 mm	15.4" / 391 mm	11.2" / 284 mm
Weight	18.0 oz / 510 g	22.7 oz / 644 g	23.2 oz / 658 g	23.4 oz / 663 g	21.8 oz / 618 g
Battery Type	CR2032 3V	CR2032 3V	CR2032 3V	CR2032 3V	CR2032 3V
Included Scope Rings	AIR32234 Picatinny High Profile			RG2W3154 Picatinny Medium Profile	

OPTIONAL ACCESSORIES

PARALLAX INDEX WHEEL

» Compatible with UTG® SCP3 Series Side AD Scopes

- 60 mm / SCP-SW060B
- 80 mm / SCP-SW080B
- 100 mm / SCP-SW100B



RUBBER SCOPE EYESHADE

» Designed to Fit Scopes with Approximately 3" Eye Relief

» Adaptor Kit Includes 3 Inserts of Varying Thicknesses to Fit Scopes with Eyepiece Diameter of 36mm, 40mm, 41.5mm or 43mm / SCP-ES403





UTG® OP3 SCOPES

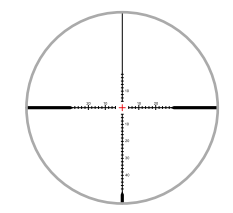

**3-12X44 / SFP / 30 MM
ETCHED GLASS UMOA / IE® 36-COLOR
/ OP3-GM3124UMOA**

**4-16X44 / SFP / 30 MM
ETCHED GLASS UMOA / IE® 36-COLOR
/ OP3-GM4164UMOA**

WWW.LEAPERS.COM | SINCE 1992

UTG® OP3 OPTICS

- » Improved Sharpness through Optimization of Internal Light Transmission Pathway, Lens Quality, and Low Aberration
- » Improved Circuitry Prevents Intermittent Illumination and Features Lower Power Consumption
- » Multi-coated Lenses for Optimal Light Transmittance and High Definition Sharpness
- » Crisp and Tactile Turret Movement with Consistent Per Click Adjustment
- » Reinforced Zero Locking/Resetting Target Turrets
- » Side Parallax Adjustment from 10 Yards to Infinity
- » Set Once Locking Eyepiece Diopter
- » Wider Turret for Use with Gloves
- » Threaded for Included Sunshade
- » IPX7 Waterproof Rated
- » US PAT. 8437079, EU PAT. EP2520894

	OP3-GM3124UMOA	OP3-GM4164UMOA
Focal Plane	SFP	SFP
Reticle	Etched Glass UMOA	Etched Glass UMOA
Illumination	IE® 36-Color	IE® 36-Color
Magnification	3X - 12X	4X - 16X
Tube Diameter	30 mm	30 mm
Objective Diameter	44 mm	44 mm
Angular FOV	6.1° - 1.9°	5° - 1.5°
Linear FOV @ 100 yds	32' - 10'	26.2' - 8'
Eye Relief	4" - 3.54" / 102 mm - 90 mm	3.7" - 3.23" / 94 mm - 82 mm
Exit Pupil	14.7 mm - 4.5 mm	11 mm - 3 mm
Diopter	-2D - +2D	-2D - +2D
Click Value	1/4 MOA	1/4 MOA
Parallax	10 yds - ∞	10 yds - ∞
Length	10.1" / 257 mm	10.7" / 272 mm
Weight	20.7 oz / 587 g	21.4 oz / 607 g
Battery Type	CR2032 3V	CR2032 3V
Included Scope Rings	RG2W3154 Picatinny Medium Profile	

OPTIONAL ACCESSORIES

PARALLAX INDEX WHEEL

- » Compatible with UTG® OP3 Series Side AD Scopes, OP3-GM3124UMOA, OP3-GM4164UMOA Only
- 80 mm / OP3-SW080**



UTG® BUG BUSTER® SCOPES

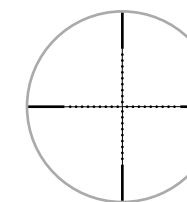

3-9X32 / SFP / 1" / FRONT AO
WIRE MIL-DOT / IE® 36-COLOR
 / SCP-M392A0IEWQ
 US PAT. 8437079
 US PAT. 8397421
 EU PAT. EP2520894

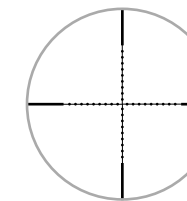

3-9X32 / SFP / 1" / FRONT AO
WIRE MIL-DOT / RG
 / SCP-M392A0LWQ
 US PAT. 8397421

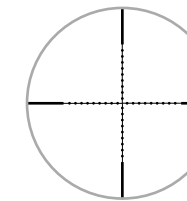

3-12X32 / SFP / 1" / SIDE AO
WIRE MIL-DOT
 / SCP-M312A0WQ
 / SCP-M312A0D

	SCP-M392A0IEWQ	SCP-M392A0LWQ	SCP-M312A0WQ	SCP-M312A0D
Focal Plane	SFP	SFP	SFP	SFP
Reticle	Wire Mil-Dot	Wire Mil-Dot	Wire Mil-Dot	Wire Mil-Dot
Illumination	IE® 36-Color	RG	N/A	N/A
Magnification	3X - 9X	3X - 9X	3X - 12X	3X - 12X
Tube Diameter	1"	1"	1"	1"
Objective Diameter	32 mm	32 mm	32 mm	32 mm
Angular FOV	7.2° - 2.7°	7.2° - 2.7°	5.9° - 1.9°	5.9° - 1.9°
Linear FOV @ 100 yds	37.7' - 14.0'	37.7' - 14.0'	31.0' - 10.0'	31.0' - 10.0'
Eye Relief	4.2" - 3.2" / 107 mm - 81 mm	4.2" - 3.2" / 107 mm - 81 mm	4.3" - 3.3" / 109 mm - 84 mm	4.3" - 3.3" / 109 mm - 84 mm
Exit Pupil	10.6 mm - 3.6 mm	10.6 mm - 3.6 mm	10.6 mm - 2.7 mm	10.6 mm - 2.7 mm
Diopter	-2D - +2D	-2D - +2D	-2D - +2D	-2D - +2D
Click Value	1/4 MOA	1/4 MOA	1/3 MOA	1/3 MOA
Parallax	3 yds - ∞	3 yds - ∞	3 yds - ∞	3 yds - ∞
Length	8.2" / 208 mm	8.2" / 208 mm	8.1" / 206 mm	8.1" / 206 mm
Weight	14.0 oz / 397 g	14.0 oz / 397 g	12.7 oz / 360 g	12.7 oz / 360 g
Battery Type	CR1632 3V	CR1620 3V	N/A	N/A
Included Scope Rings	RQ2W1154 Picatinny Medium Profile		RT2D1154 Dovetail Medium Profile	

OPTIONAL ACCESSORIES

PARALLAX INDEX WHEEL

» Compatible with Side AO BUG BUSTER® Optic, SCP-M312A0WQ, SCP-M312A0D Only

80 mm / SCP-SW080BB



TRUE HUNTER®



UTG® TRUE HUNTER® SCOPES

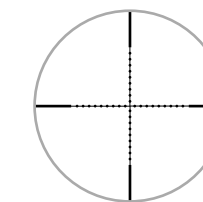

3-9X40 / SFP / 1"
WIRE MIL-DOT / IE® 36-COLOR
 / SCP-U394AOIEW
 / SCP-U394AOIEW

4-16X40 / SFP / 1"
WIRE MIL-DOT / IE® 36-COLOR
 / SCP-U4164AOIEW

US PAT. 8437079, EU PAT. EP2520894

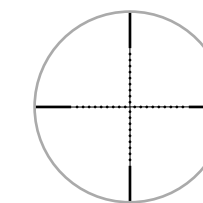

4X32 / SFP / 1"
WIRE MIL-DOT
 / SCP-U432FD

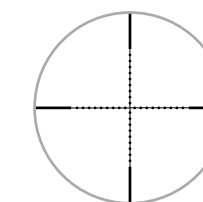

6-24X50 / SFP / 1"
WIRE MIL-DOT / IE® 36-COLOR
 / SCP-U6245AOIEW

US PAT. 8437079, EU PAT. EP2520894

	SCP-U394AOIEW	SCP-U394AOIED	SCP-U4164AOIEW	SCP-U432FD	SCP-U6245AOIEW
Focal Plane	SFP	SFP	SFP	SFP	SFP
Reticle	Wire Mil-Dot	Wire Mil-Dot	Wire Mil-Dot	Wire Mil-Dot	Wire Mil-Dot
Illumination	IE® 36-Color	IE® 36-Color	IE® 36-Color	N/A	IE® 36-Color
Magnification	3X - 9X	3X - 9X	4X - 16X	4X	6X - 24X
Tube Diameter	1"	1"	1"	1"	1"
Objective Diameter	40 mm	40 mm	40 mm	32 mm	50 mm
Angular FOV	6.8° - 2.3°	6.8° - 2.3°	4.4° - 1.1°	6.1°	2.7° - 0.8°
Linear FOV @ 100 yds	35.6' - 12'	35.6' - 12'	23.0' - 6.0'	32'	14.4' - 4.1'
Eye Relief	3.9" - 3.2" / 99 mm - 81 mm	3.9" - 3.2" / 99 mm - 81 mm	3.2" - 3.0" / 81 mm - 76 mm	3.4" / 86 mm	3.2" - 3.0" / 81 mm - 76 mm
Exit Pupil	13 mm - 4.5 mm	13 mm - 4.5 mm	10.0 mm - 2.5 mm	8.0 mm	8.3 mm - 2.2 mm
Diopter	-2D - +2D	-2D - +2D	-2D - +2D	-2D - +2D	-2D - +2D
Click Value	1/4"	1/4"	1/4"	1/4"	1/4"
Parallax	5 yds - ∞	5 yds - ∞	5 yds - ∞	Preset @ 35 yds	10 yds - ∞
Length	12.6" / 320 mm	12.6" / 320 mm	14.5" / 368 mm	11.8" / 300 mm	15.5" / 394 mm
Weight	21.1 oz / 598 g	21.1 oz / 598 g	22.3 oz / 632 g	14.4 oz / 408 g	26.5 oz / 751 g
Battery Type	CR2032 3V	CR2032 3V	CR2032 3V	N/A	CR2032 3V
Included Scope Rings	RQ2W1204 Picatinny High Profile	RGPM-25M4 Dovetail High Profile	RGWM-25H4 Picatinny High Profile	RGPM-25M2 Dovetail Medium Profile	RQ2W1204 Picatinny High Profile

OPTIONAL ACCESSORIES

RUBBER SCOPE EYE SHADE

- » Designed to Fit Scopes with Approximately 3" Eye Relief
- » Prevents Glare and Improves Focus on Target by Eliminating Distractions from Peripheral Movement
- » Adaptor Kit Includes 3 Inserts of Varying Thicknesses to Fit Scopes with Eyepiece Diameter of 36mm, 40mm, 41.5mm or 43mm

/ SCP-ES403



UTG® CROSSBOW SCOPES



UTG® TRUE HUNTER® CROSSBOW SCOPE

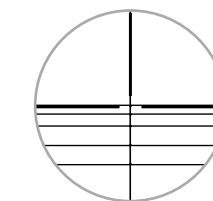

4X32 / SFP / 1"
PRO 5-STEP / RG
 / SCP-M4CR5WQ
 US PAT. 8397421



UTG® OP3 CROSSBOW SCOPE

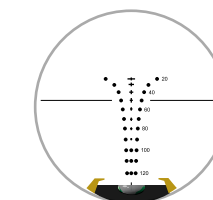

1.5-6X36 / SFP / 30 MM
ETCHED GLASS 130 HUNTER BDC / RG
 / OP3-G1563CRWQ

130 HUNTER BDC RETICLE

The bubble leveler is internal and is not a separate external attachment. Located unobtrusively at the 6 o'clock position, the bubble leveler aids in correcting any cant the user may have while aiming. Being internal allows the user to focus their attention primarily on the target and reticle, while secondarily allowing for quick cant adjustments by seeing the leveler through their peripherals.

RANGE ESTIMATION

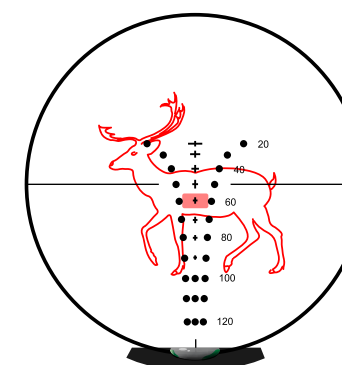
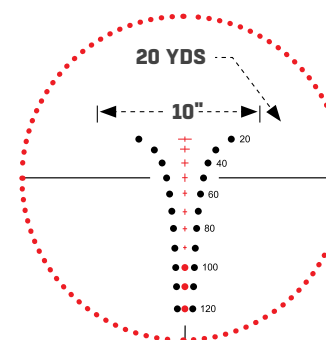

	OP3-G1563CRWQ	SCP-M4CR5WQ
Focal Plane	SFP	SFP
Reticle	Etched Glass 130 Hunter	Wire PRO 5-Step
Illumination	RG	RG
Magnification	FPS Compensation 250 - 475 (1.5X - 6X)	4X
Tube Diameter	30 mm	1"
Objective Diameter	36 mm	32 mm
Angular FOV	10° - 2.7°	5.2°
Linear FOV @ 100 yds	52.5' - 13.98'	27.2'
Eye Relief	5.8" - 4.25" / 147 mm - 108 mm	3.8" / 97 mm
Exit Pupil	24 mm - 6.2 mm	8.0 mm
Diopter	-2D - +2D	-2D - +2D
Click Value	1/2 MOA	1/4"
Parallax	10 yds - ∞	Preset @ 50 yds
Length	8.2" / 208 mm	8.2" / 208 mm
Weight	16.0 oz / 454 g	12.3 oz / 349 g
Battery Type	CR1632 3V	CR1620 3V
Included Scope Rings	RG2W3154 Picatinny Medium Profile	RQ2W1104 Picatinny Low Profile



UTG® LONG EYE RELIEF SCOPES



UTG® SCP3 SCOUT SCOPE

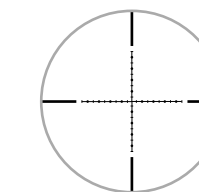

2-7X44 / SFP / 30MM
ETCHED GLASS MIL-DOT / IE® 36-COLOR
 / SCP3-274LA0IEW
 US PAT. 8437079, EU PAT. EP2520894



UTG® TRUE HUNTER® HANDGUN SCOPE

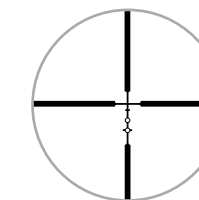

2-7X32 / SFP / 1"
PDC / RG
 / SCP-27PRGW

UTG® LONG EYE RELIEF SCOPES

- » Built on TRUE STRENGTH® Platform, Completely Sealed and Nitrogen Filled, Shockproof, Fogproof and Rainproof
- » Most Consistent and Precise 1/4 MDA per Click Windage/Elevation Adjustment
- » Emerald Coated Lenses to Achieve Maximum Light Transmission for Best Clarity

	SCP3-274LA0IEW	SCP-27PRGW
Focal Plane	SFP	SFP
Reticle	Etched Mil-Dot	Wire PDC
Illumination	IE® 36-Color	RG
Magnification	2X - 7X	2X - 7X
Tube Diameter	30 mm	1"
Objective Diameter	44 mm	32 mm
Angular FOV	6.1° - 1.9°	2.5° - 1.3°
Linear FOV @ 100 yds	32.0' - 10.0'	12.9' - 7.0'
Eye Relief	11.0" - 9.5" / 279 mm - 241 mm	25.0" - 13.8" / 635 mm - 351 mm
Exit Pupil	22.0 mm - 6.3 mm	16.0 mm - 5.0 mm
Diopter	-2D - +2D	-2D - +2D
Click Value	1/4"	1/4"
Parallax	10 yds - Infinity	Preset @ 35 yds
Length	11.5" / 292 mm	9.4" / 239 mm
Weight	25.4 oz / 720 g	14.0 oz / 397 g
Battery Type	CR2032 3V	CR1620 3V
Included Scope Rings	RG2W3154 Picatinny 30 mm / Medium Profile	RGWM-25M4 Picatinny 1" / Medium Profile



MRAD RETICLES

GLASS RETICLE
M1 MRAD

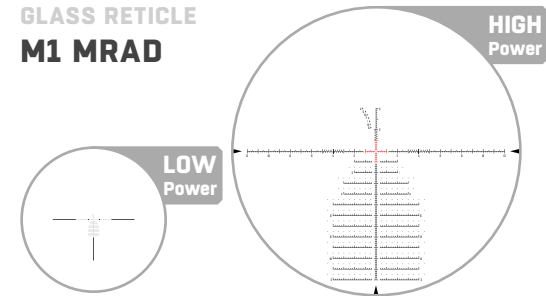

A tried-and-true MRAD Reticle made for true marksmen looking to challenge themselves at ranges most could not reach. 12 Mil of holdovers broken into .2 Mil increments for exact shot placement. Four Mil of hold-unders for that prairie dog that pops up a little close and a 1 Mil section of .1 Mil increments for fine measuring, if you know you know. Twenty-four Mil of wind holds on the main horizontal stadia includes 2 Mil of .1 Mil increments on both sides.

Do not be afraid to have fun in the wind with up to 4.5 Mil of wind holds. Finally, if you feel like just dialing, a 0.05 Mil dot for your center hold will prove to be the precise aiming point needed to hit your mark. The center hold and one Mil of the crosshairs are the only parts of the M2 MRAD reticle that illuminates.

» iX645FM1 / 4.5-27X56mm / RG (pg.025) **NEW**

GLASS RETICLE
M2 MRAD

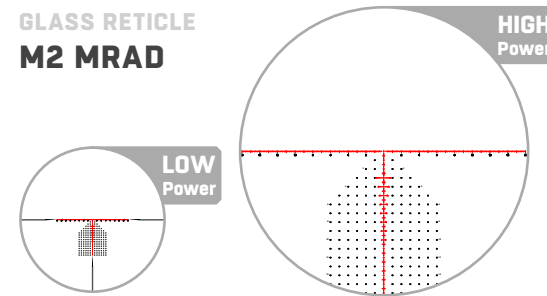

A modern clutter free and minimalist MRAD reticle, built for the tactical yet simple marksman. A wide-open top half of the glass makes the most of your FOV with a .2 Mil floating donut as your center hold. Additional holds can be found throughout the main vertical stadia spaced out in 1 Mil increments. Wind holds are also spaced out in 1 Mil increments out to 6 Mil. Your main horizontal stadia has .2 Mil increments on the bottom and .5 Mil hash up top with 2 Mil of .1 Mil increments for fine measuring found on both sides. Your main vertical stadia is spaced out in .2 Mil increments with .5 Mil markings in the center of the segments. 2 Mil of .1 Mil increments are also applied to this stadia. We have included ranging brackets from 300 yards out to 1,000 for targets 6-9 inches or 12-18 inches wide. The main stadia's and the ranging brackets will be the only illuminated portions of the reticle.

» iX645FM2 / 4.5-27X56mm / RG (pg.025) **NEW**

GLASS RETICLE
M3 MRAD

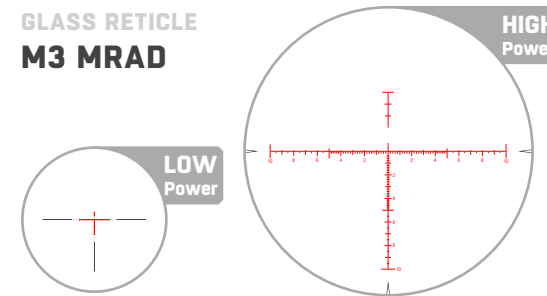

Back to the basics with a simple MRAD style crosshair. You start off with 4 Mil of .2 Mil increments. You get 1 Mil of .1 Mil increments then it changes to .5 Mil increments out to 10 Mil. A set of hold-unders from 2-5 Mil tops it off. No clutter just nice and simple. The entire crosshair beside its hold-under portion is illuminated.

» iX645FM2 / 4.5-27X56mm / RG (pg.025) **NEW**

MOA RETICLES

GLASS RETICLE
**RANGE-ESTIMATING
A1 MOA**

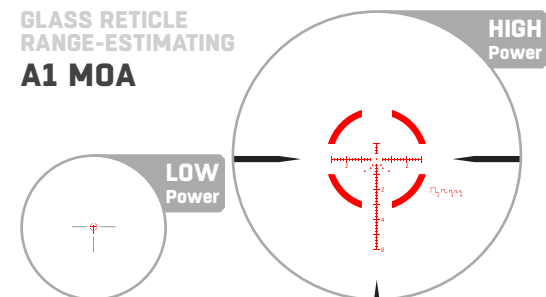

At 1X, a quick-to-acquire T-Dot enclosed within a 68 MOA segmented circle makes close up work, quick and to the point, functioning similarly to a dot sight. At higher magnifications the reticle opens up to provide users with a crisp 1 MOA center dot, range estimation out to 600 yards, and hash marks up to 60 MOA vertically for holdover and 30 MOA horizontally left and right in 2 MOA increments.

» iX801FA1 / 1-8X28mm / RG (pg.019) **NEW**
» AS601FA1 / 1-6X24mm / RG (pg.031) **NEW**

GLASS RETICLE
A2 MOA

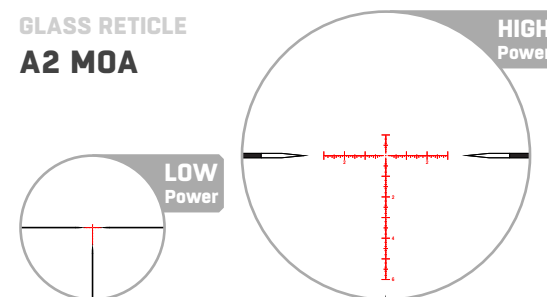

Clutter-free at both low and high magnifications to supplement overall FOV qualities, the German Duplex inspired A2 MOA reticle features sub-tensions that transition from being bolded to see-through while tapering down to a fine point towards the reticle's center. The center crosshair, at low magnification, provides a quick-to-acquire T-Dot and fully illuminates.

The T-Dot at higher magnification opens up and provides an unobtrusive 0.5 MOA floating center dot which focuses the eyes to the center of the reticle and frees up space between it and the remainder of the reticle to provide a better view of critical target details. The reticle spans 10 MOA up and 60 MOA down and 30 MOA left and right in 1 MOA increments.

» iX403FA2 / 3-12X50mm / RG (pg.021) **NEW**
» iX603FA2 / 3-18X44mm / RG (pg.023) **NEW**
» iX602FA2 / 2-12X36mm / RG (pg.023) **NEW**
» AS303FA2 / 3-9X36mm / RG (pg.033) **NEW**
» AS403FA2 / 3-12X44mm / RG (pg.035) **NEW**

GLASS RETICLE
UMOA

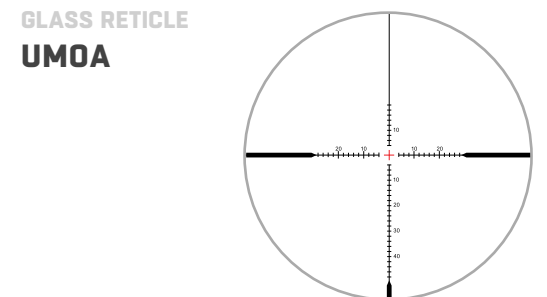

The UMOA reticle features hash marks at minute of angle increments for precise range estimation and bullet drop and wind drift compensation. This reticle is the best choice for long-range precision shooters who want clear adjustments and to rapidly calculate holds. The reticle's center crosshair can be illuminated to assist aiming under different light conditions.

» DP3-GM3124UMOA / 3-12X44mm / IE 36-Color (pg.043)
» DP3-GM4164UMOA / 4-16X44mm / IE 36-Color (pg.043)

MRAD RETICLES

GLASS RETICLE
MIL-DOT

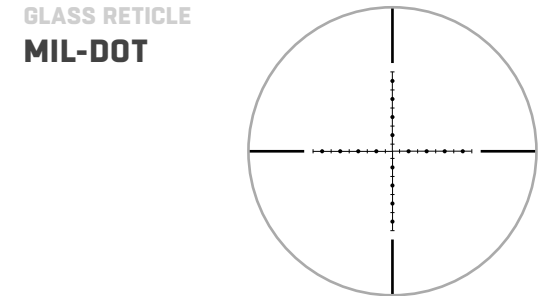

The crosshair has dots and dashes spread equally along the X and Y axis. The distance between two adjacent marks subtends to 1 milli-radian. The etched-glass reticle offers our discerning users the sharpest Mil-dot reticle for precise range estimation.

» SCP3-274LA01EW / 2-7X44mm / IE 36-Color (pg.051)

WIRE RETICLE
MIL-DOT

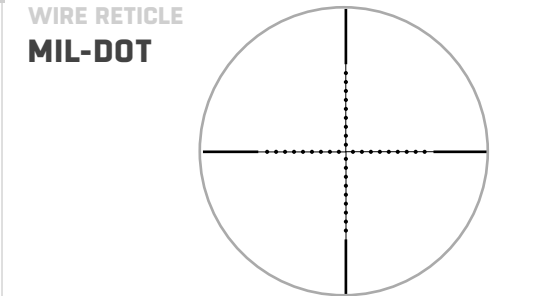

The crosshair has multiple dots spread equally along the X and Y axis. The distance between two adjacent marks subtends to 1 milli-radian. The traditional wire reticle is robust and holds up against strong recoil and offers a clear aiming reference without compromise.

- » SCP3-U312A01EW / 3-12X44mm / IE 36-Color (pg.041)
- » SCP3-U416A01EW / 4-16X44mm / IE 36-Color (pg.041)
- » SCP3-UM312A01EW / 3-12X44mm / IE 36-Color (pg.041)
- » SCP3-UM416A01EW / 4-16X44mm / IE 36-Color (pg.041)
- » SCP-M392A01EWQ / 3-9X32mm / IE 36-Color (pg.045)
- » SCP-U394A01ED / 3-9X40mm / IE 36-Color (pg.047)
- » SCP-U394A01EW / 3-9X40mm / IE 36-Color (pg.047)
- » SCP-U4164A01EW / 4-16X40mm / IE 36-Color (pg.047)
- » SCP-U6245A01EW / 4-24X50mm / IE 36-Color (pg.047)
- » SCP-M392A01WQ / 3-9X32mm / RG (pg.045)
- » SCP-U432FD / 4X32mm / RG (pg.047)
- » SCP-M312A0D / 3-12X32mm (pg.045)
- » SCP-M312A0WQ / 3-12X32mm (pg.045)

BDC RETICLES

GLASS RETICLE
B1 BDC

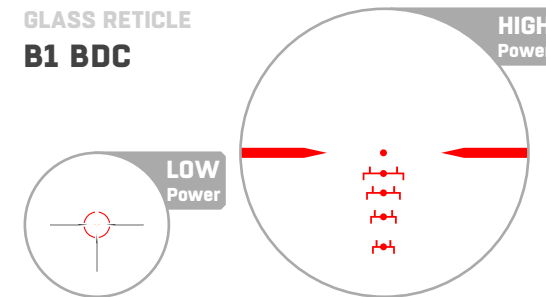

A straight forward ballistic drop compensating (BDC) reticle with a wide clutter-free sight picture. For up-close work at low magnification, a segmented circle surrounds a T-Dot crosshair for transitioning, acquiring, and placing shots quickly on target. Additionally, tapered and see-through sub-tensions similar to that of a German Duplex reticle draws the eyes to the center of the reticle.

At higher magnification, the T-dot crosshair opens up to reveal a floating 1 MOA dot with the tapered tips of the sub-tensions to its left and right, continuing the drawing of the eyes to the center. Just below the 1 MOA dot are four additional 1 MOA dots for holdovers at 300, 400, 500, and 600 yards. Each holdover dot is accompanied by range estimating brackets. Determining the range to target is easily accomplished by sizing up the targets' shoulder width within the correct bracket. The segmented circle and T-dot crosshair are the only parts of the B1 BDC reticle that illuminates.

» AS601FB1 / 1-6X24mm / RG (pg.031) **NEW**

GLASS RETICLE
BG4

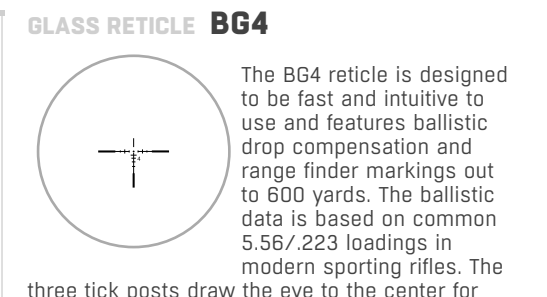

The BG4 reticle is designed to be fast and intuitive to use and features ballistic drop compensation and range finder markings out to 600 yards. The ballistic data is based on common 5.56/.223 loadings in modern sporting rifles. The three tick posts draw the eye to the center for rapid acquisition at close range, while the drop compensation allows for rapid engagement of targets throughout the platform's effective range.

» SCP3-18IEBG4 / 1-8X18mm / RG (pg.041)

GLASS RETICLE
130 HUNTER BDC

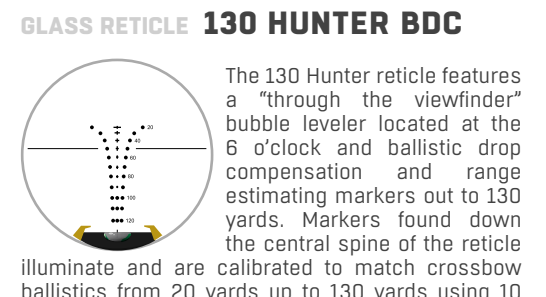

The 130 Hunter reticle features a "through the viewfinder" bubble leveler located at the 6 o'clock and ballistic drop compensation and range estimating markers out to 130 yards. Markers found down the central spine of the reticle illuminate and are calibrated to match crossbow ballistics from 20 yards up to 130 yards using 10 yard increments. The center of the reticle marker is calibrated for a 50 yard target distance for general ease of use.

» OP3-G1563CRWQ / 1.5-6X36mm / RG (pg.049)

WIRE RETICLE
PRO 5-STEP

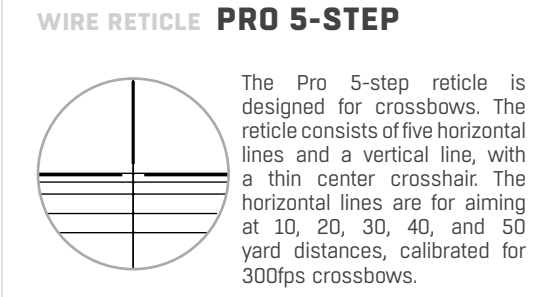

» SCP-M4CR5WQ / 4X32mm / RG (pg.049)

WIRE RETICLE
PDC

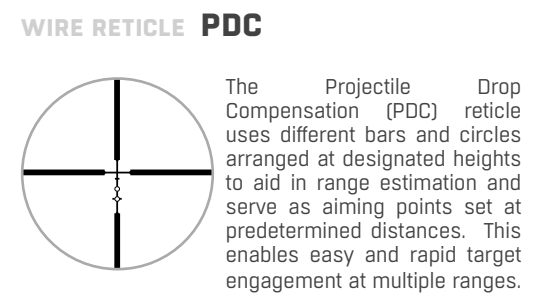

» SCP-27PRGW / 2-7X32mm / RG (pg.051)

DOT SIGHTS & MAGNIFIERS

CONFIDENCE SQUARED AWAY.

Effective targeting solutions for both long guns and handguns. Mounted directly, our wide selection of MRDS (Micro Reflex Dot Sights) are quick to install on the most popular of optics-ready double-stack or single-stack pistols with versatile mounting options available for installation on a variety of long gun applications. Follow through with confidence shot-to-shot with our long gun closed-emitter dot sights with models available in single-dot, T-dot, or circle-dot reticles. Looking to touch out farther? Pair one with our 3X flip-to-side magnifier.



JUMP TO A SERIES

- | **UTG® ACCU-SYNC™ DOT SIGHTS [NEW]** 058
 - DS2521R for Mini ACOG® Footprint 059
 - DS2018R for Mini ACOG® Footprint 059
- | **UTG PRO® MRDS [NEW]** 060
- | **UTG® OP3 MICRO MRDS**
 - Mini Micro MRDS for SHIELD RMSC Footprint 062
 - MRDS/SL/SLS for DOCTER® Footprint 063
 - MRDS/SLS for RMR® Footprint 063
- | **UTG® ITA DOT SIGHTS** 064
- | **UTG® 3X FLIP-TO-SIDE MAGNIFIER** 064

(THIRD PARTY TRADEMARKS MAY BE USED IN THIS CATALOG FOR USER CONVENIENCE TO INDICATE THE FIT OR COMPATIBILITY OF THE APPLICABLE PRODUCT.)





ACCURACY SYNCHRONIZED ACCU-SYNC™

ACCU-SYNC® DOT SIGHTS

UTG® ACCU-SYNC™ dot sights come in a compact and subcompact size and feature a red illuminated 3 MOA dot with 8 manually adjusted brightness intensity settings to choose from. Illumination memory conveniently gets users right back to the last brightness setting used upon activation. Fully sealed, ACCU-SYNC™ dot sights are IPX7 waterproof rated and constructed from matte black anodized 6061-T6 aluminum. Optimized for low power consumption and powered by a single CR2032 battery, a 30,000+ hour battery life (at middle brightness) comes standard.

The mounting base uses the common mini ACOG® footprint and is configured for a lower 1/3 co-witness out of the box. Removing the included riser drops the height down to that of a low mount providing users two commonly used height profiles for different firearm applications. In addition, the base features squared recoil stops and our QR (quick release) mount, making for a quick installation and removal, reliable return to zero, and is compatible with Picatinny rails with widths that may even be out of spec. Tool-free tension adjustment is locked in place via a gear and spring-loaded locking lever interface, allowing users to set it once and forget it.

QUICK TO ACQUIRE

Red 3 MOA Dot with 8 Brightness Settings and 30,000+ Hours Battery Life



ACCU-SYNC® QR

Low Profile Quick Release (QR) Mount with Tool-free Tension Adjustment



SHOOTER CONFIGURABLE

Configured for a Lower 1/3 Co-witness and is Mini ACOG® Footprint Compatible



RELIABLE CONSTRUCTION

IPX7 Waterproof Rated, Precision Machined from Matte Black 6061-T6 Aluminum with Impact Resistant Tempered Glass Lens



ACCU-SYNC™ 2018R & 2521R DOT SIGHTS



ACCU-SYNC® 2018R
Manual Brightness
Mini ACOG® Footprint / Red 3 MOA / OP-DS2018R



ACCU-SYNC® 2521R
Manual Brightness
Mini ACOG® Footprint / Red 3 MOA / OP-DS2521R



ACCU-SYNC™ 2018R & 2521R DOT SIGHTS NEW

- » Precision Machined from 6061-T6 Aluminum and Finished in a Matte Black Anodization
- » Wide Field of View Lens Diameter
- » Impact Resistant Tempered Glass Lens
- » 3 MOA Red Dot with 8 Brightness Settings
- » 30,000+ Hours Battery Life at Middle Brightness Setting
- » Snag-free Flush Turrets with Crisp 1 MOA Per Click Adjustment at 100 Yards
- » IPX7 Waterproof Rated
- » Low Profile Quick Release (QR) Mini ACOG® Mount with Lower 1/3 Co-witness Riser Included

	OP-DS2018R	OP-DS2521R
Lens Diameter	0.75" / 19 mm	0.79" / 20 mm
Reticle / Illumination	Red 3 MOA Dot	Red 3 MOA Dot
Illumination Mode	Manual, 8 Settings	Manual, 8 Settings
Adjustment	1 MOA Per Click	1 MOA Per Click
Material	Anodized AL6061	Anodized AL6061
Battery Type	CR2032 3V	CR2032 3V
Battery Life	30,000+ hrs	30,000+ hrs
Mount Footprint	Mini ACOG®, with Lower 1/3 Co-witness Riser	
Length x Width	2.24" X 1.64"	2.66" X 1.66"
Weight (w/Battery)	5.4 oz	6.1 oz

UTG PRO® MRDS



AL 7075 Housing / Constant-on Automatic Brightness
SHIELD RMSC Footprint / Red 3 MOA / OPUMR01

UTG PRO®  **NEW**

MRDS

- » Proudly Designed and Made in USA
- » High Clarity Coated Glass Lens Housed within a Precision Machined Matte Black Anodized 7075-T6 Aluminum Body
- » Constant-on Automatic Brightness Adjusting Red 3 MOA Single Dot
- » IPX7 Waterproof Rated
- » Lower 1/3 Co-witness with Most Standard Height Iron Sights
- » Protective Optic Cover Included
- » Out-of-the-box Compatible with SIG P365X/XL, GLOCK 43X/48 MOS, WALTHER PPS M2 RMSC, SPRINGFIELD ARMORY HELLCAT OSP, RUGER MAX-9, S&W PERFORMANCE CENTER M&P SHIELD M2.0, and Most Other Optics-Ready Pistol Platforms
- » Includes M3, M4, and #6-32 Hardware Screws for Greater Optics-Ready Pistol Platform Compatibility



Windage/Elevation Adjustment

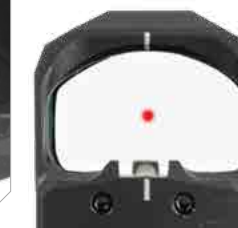

Integral Rear Backup Iron Sight Milled into Body

	OPUMR01
Lens Diameter	0.85" X 0.59"
Reticle / Illumination	Red 3 MOA Dot
Illumination Mode	Automatic, Constant-on
Material	Hard Coat Anodize AL7075
Battery Type	CR2032
Battery Life	30,000+ hrs
Mount Footprint	SHIELD RMSC
Length x Width	1.62" X 0.98"
Weight (w/Battery)	0.71 oz



OP3 MICRO MRDS



OP3 MINI MICRO
Constant-on Automatic Brightness
SHIELD RMSC Footprint / Red 3 MOA / OT-RDM16R

OP3 MINI MICRO MRDS

- » High Clarity Coated Glass Lens Housed within a Precision Machined Matte Black Anodized 6061-T6 Aluminum Body
- » IPX7 Waterproof Rated
- » Lower 1/3 Co-witness with Most Standard Height Iron Sights
- » Integral Rear Backup Iron Sight Milled into Body
- » Protective Optic Cover Included
- » Out-of-the-box Compatible with SIG P365X/XL, GLOCK 43X/48 MOS, WALTHER PPS M2 RMSC, SPRINGFIELD ARMORY HELLCAT OSP, RUGER MAX-9, S&W PERFORMANCE CENTER M&P SHIELD M2.0, and Most Other Optics-Ready Pistol Platforms

	OT-RDM16R
Lens Diameter	0.85" X 0.59"
Reticle / Illumination	Red 3 MOA Dot
Illumination Mode	Automatic, Constant-on
Material	Anodized AL6061
Battery Type	CR2032
Battery Life	30,000+ hrs
Mount Footprint	SHIELD RMSC
Length x Width	1.60" X 0.95"
Weight (w/Battery)	0.70 oz



OP3 MICRO
Manual Brightness
DOCTER® Footprint / Red 4 MOA / OP-RDM20R
DOCTER® Footprint / Green 4 MOA / OP-RDM20G
RMR® Footprint / Red 4 MOA / OP-RMR20R



OP3 MICRO SL
Side Loading Battery / Manual Brightness
DOCTER® Footprint / Red 4 MOA / OP-RDM20CT



OP3 MICRO SLS
Side Loading Battery / Manual & Auto Sensing Brightness
DOCTER® Footprint / Red 4 MOA / OP-RDM20CTS
RMR® Footprint / Red 4 MOA / OP-RMR20CTS

OP3 MICRO MRDS

- » IPX7 Waterproof Rated
- » Coated Wide 23mm FOV Glass Lens
- » Co-witnesses with Most Suppressor Height Iron Sights
- » Tertiary Aiming Point Laser Engraved on Rear Face of Housing

	OP-RDM20R	OP-RDM20G	OP-RMR20R	OP-RDM20CT	OP-RDM20CTS	OP-RMR20CTS
Lens Diameter	0.89" X 0.68"	0.89" X 0.68"	0.89" X 0.68"	0.89" X 0.68"	0.89" X 0.68"	0.89" X 0.68"
Reticle / Illumination	Red 4 MOA Dot	Green 4 MOA Dot	Red 4 MOA Dot	Red 4 MOA Dot	Red 4 MOA Dot	Red 4 MOA Dot
Illumination Mode	Manual	Manual	Manual	Manual	Manual / Automatic	Manual / Automatic
Adjustment	1 MOA Per Click	1 MOA Per Click	1 MOA Per Click	1 MOA Per Click	1 MOA Per Click	1 MOA Per Click
Material	Anodized AL6061	Anodized AL6061	Anodized AL6061	Anodized AL6061	Anodized AL6061	Anodized AL6061
Battery Type	CR2032 3V	CR2032 3V	CR2032 3V	CR1632 3V	CR1632 3V	CR1632 3V
Battery Life	55,000+ hrs	20,000+ hrs	55,000+ hrs	15,000+ hrs	15,000+ hrs	15,000+ hrs
Mount Footprint	For Docter®	Docter®	RMR®	Docter®	Docter®	RMR®
Length x Width	1.90" X 1.14"	1.90" X 1.14"	1.78" X 1.14"	1.90" X 1.14"	1.90" X 1.14"	1.78" X 1.14"
Weight (w/Battery)	1.2 oz	1.2 oz	1.1 oz	1.2 oz	1.2 oz	1.2 oz



ITA DOT SIGHTS & MAGNIFIER



» Bidirectional Offset Mount Included

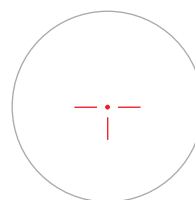

6.0" ITA DOT SIGHT

- » Built on TRUE STRENGTH® Platform
- » Unlimited Eye Relief and Intuitive, Quick-to-Acquire Red/Green T-dot Reticle for Swift Execution of T-Zone and Center Mass Hits
- » Premium Zero Lockable and Zero Resettable Target Turrets with Most Consistent, Precise and Reliable 1/2 MOA per Click Adjustment and Zero Hold Capability
- » 42mm Center Height for 1/3 Co-witness of Front and Rear Iron Sights
- » US PAT. 8397421

RG T-Dot / Bidirectional QD Mount / SCP-TDQDQ

3X QD FLIP-TO-SIDE MAGNIFIER

- » Windage/Elevation Adjustability for Optimum View Centering
- » 42mm Center Height for Most Common Dot Sight Combination
- » Perfect Match with: SCP-DS3840W, SCP-DS3039W, SCP-DS3840TDQ
- » Match with 0.60" Riser: SCP-RD40RGW-A
- » Match with 0.75" Riser: SCP-RG40SDQ, SCP-RG40CDQ
- » US PAT. 8397421, US PAT. D672839, EU PAT. EP1984576-0001

Integral QD Mount / SCP-MF3WEQS



» Offset Riser Applications

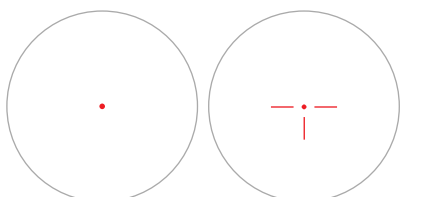

4.2" ITA DOT SIGHTS

- » US PAT. 8397421
- RG 4 MOA Single Dot / Adjustable Riser / SCP-DS3840W
- RG T-Dot / Adjustable Riser / SCP-DS3840TDQ

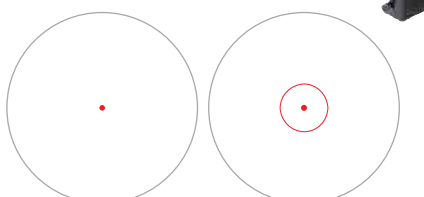

3.8" ITA DOT SIGHTS

- » US PAT. 8397421
- RG 4 MOA Single Dot / Integral Mount / SCP-RD40RGW-A
- RG 4 MOA Single Dot / Integral Qd Mount / SCP-RG40SDQ
- RG Circle Dot / Integral QD Mount / SCP-RG40CDQ



» Offset Riser Applications

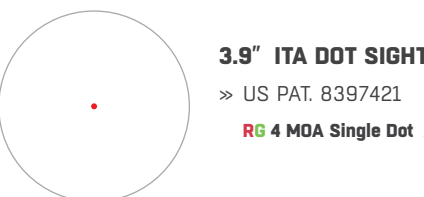

3.9" ITA DOT SIGHT

- » US PAT. 8397421
- RG 4 MOA Single Dot / Adjustable Riser / SCP-DS3039W

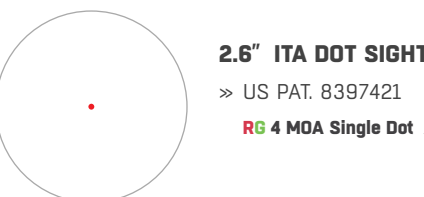

2.6" ITA DOT SIGHT

- » US PAT. 8397421
- RG 4 MOA Single Dot / Integral QD Mount / SCP-DS3026W

	SCP-MF3WEQS	SCP-TDQDQ	SCP-DS3840W	SCP-DS3840TDQ	SCP-DS3039W	SCP-RD40RGW-A	SCP-RG40SDQ	SCP-RG40CDQ	SCP-DS3026W
Reticle / Illumination	N/A	T-DOT / RG	Single Dot / RG	T-DOT / RG	Single Dot / RG	Single Dot / RG	Single Dot / RG	Circle Dot / RG	Single Dot / RG
Magnification	3X	1X	1X	1X	1X	1X	1X	1X	1X
Main Tube Diameter	44 mm	38 mm	38 mm	38 mm	30 mm	38 mm	38 mm	38 mm	30 mm
Objective Diameter	25 mm	39 mm	32 mm	32 mm	26 mm	30 mm	30 mm	30 mm	21 mm
FOV @ 100 Yards	45'	85'	103'	103'	75'	95'	95'	95'	95'
Eye Relief	2"	Unlimited	Unlimited	Unlimited	Unlimited	Unlimited	Unlimited	Unlimited	Unlimited
Exit Pupil	8.7 mm	Unlimited	Unlimited	Unlimited	Unlimited	Unlimited	Unlimited	Unlimited	Unlimited
Click Value	N/A	1/2"	1/2"	1/2"	1/2"	1/2"	1/2"	1/2"	1/2"
Center Height	42 mm	42 mm	32 mm (42 mm w/riser)	32mm (42mm w/riser)	30 mm (40 mm w/riser)	25.5 mm	25.5 mm	25.5 mm	25 mm
Length	4"	6"	4.2"	4.2"	3.9"	3.8"	3.8"	3.8"	2.6"
Weight	11.82 oz	13.1 oz	8.7 oz	8.7 oz	8.3 oz	9.4 oz	8.4 oz	8.4 oz	4.9 oz
Battery Type	N/A	CR1620 3V	CR1620 3V	CR1620 3V	CR1620 3V	CR2032 3V	CR2032 3V	CR2032 3V	CR1620 3V



OPTIC MOUNTS & RINGS

WHAT IT TAKES TO
STAY ZEROED.

There is a lot more involved in staying zeroed that goes well beyond simply torquing down some screws. Surface interfaces must adhere to strict tolerances, thread engagement must be clean and precise to prevent cross-threading, mounts must be squared, and locking lugs must be able to return to zero and handle recoil report. Our vast array of optic mounts & rings checks all the boxes from simple adaptors, drilled and tapped receiver mounts, quick release integral mounts, to our legendary UTG PRO® Precision Optics Interface (P.O.I.®) scope rings.

JUMP TO A SERIES

SCOPE RINGS & MOUNTS

UTG PRO® P.O.I.® Scope Rings	068
ACCU-SYNC® QR Scope Rings	070
ACCU-SYNC® QR Cantilever Mounts	072
ACCU-SYNC® Cantilever Scope Rings & Mounts	073
UTG® Scope Rings & Mounts	074

DOVETAIL-TO-PICATINNY MOUNTS

076

DRILLED & TAPPED RECEIVER MOUNTS

077

SHOTGUN SIDE SADDLE MOUNTS

077

DEDICATED OPTIC MOUNTS

FOR UTG® OP3 MICRO	079
FOR TRIJICON® RMR	081
FOR AIMPOINT® T1	081
FOR TRIJICON® MRO	081

AK RECEIVER MOUNTS

082

PICATINNY RISERS

083

(THIRD PARTY TRADEMARKS MAY BE USED IN THIS CATALOG FOR USER CONVENIENCE TO INDICATE THE FIT OR COMPATIBILITY OF THE APPLICABLE PRODUCT.)



Precision Optics Interface®



RATED UP TO
.50 BMG

P.O.I.® SCOPE RINGS | PRECISION OPTICS INTERFACE



LOW PROFILE
1 inch / RWU012510
30 mm / RWU013010

PICATINNY
MEDIUM PROFILE
1 inch / RWU012515
30 mm / RWU013015
34 mm / RWU013415

HIGH PROFILE
1 inch / RWU012520
30 mm / RWU013022
34 mm / RWU013420

LOW PROFILE
1 inch / RDU013010

DOVETAIL
MEDIUM PROFILE
1 inch / RDU012515
30 mm / RDU013015

HIGH PROFILE
1 inch / RDU012520
30 mm / RDU013022

UTG PRO®

P.O.I.® SCOPE RINGS | PRECISION OPTICS INTERFACE

- » Progressively Machined Inner Diameter for a Precise and Seamless Ring-to-Scope Interface
- » Low Profile and Flush-fitting Locking Side Plate Features Dual Spring-loaded Guides Ensuring a Secure and Repeatable Zero
- » Integral Squared Recoil Stops Eliminate Possibility of Forward and Rearward Movement Under Recoil
- » Rated up to .50 BMG
- » US PAT. D771218, EU PAT. 002761064-0001

	RWU012510	RWU012515	RWU012520	RWU013010	RWU013015	RWU013022	RWU013415	RWU013420	RDU012515	RDU012520	RDU013010	RDU013015	RDU013022
Ring Type	Picatinny Scope Rings (set of 2)								Dovetail Scope Rings (set of 2)				
Ring Diameter	1"	1"	1"	30 mm	30 mm	30 mm	34 mm	34 mm	1"	1"	30 mm	30 mm	30 mm
Profile	Low	Medium	High	Low	Medium	High	Medium	High	Medium	High	Low	Medium	High
Max. Scope Outer Dia.	45 mm	55 mm	65 mm	49 mm	59 mm	73 mm	63 mm	73 mm	55 mm	65 mm	49 mm	59 mm	73 mm
Center Height	23 mm	28 mm	33 mm	25 mm	30 mm	37 mm	32 mm	37 mm	28 mm	33 mm	25 mm	30 mm	37 mm
Saddle Height	10 mm	15 mm	20 mm	10 mm	15 mm	22 mm	15 mm	20 mm	15 mm	20 mm	10 mm	15 mm	22 mm
Ring Width	22 mm	22 mm	22 mm	22 mm	22 mm	22 mm	22 mm	22 mm	22 mm	22 mm	22 mm	22 mm	22 mm



ACCURACY SYNCHRONIZED QUICK RELEASE
ACCU-SYNC® QR

ACCU-SYNC® QR SCOPE RINGS



LOW PROFILE
 1 inch / AQR110
 30 mm / AQR310

MEDIUM PROFILE
 1 inch / AQR115
 30 mm / AQR315
 34 mm / AQR415

PICATINNY HIGH PROFILE
 1 inch / AQR120
 30 mm / AQR322
 34 mm / AQR420

X-HIGH PROFILE
 34 mm / AQR422

2X-HIGH PROFILE
 34 mm / AQR432

ACCU-SYNC® QR SCOPE RINGS

- » Tool-free and Wide-Range Tension Adjustment
- » Accommodates Even Most Out-of-spec Picatinny Rails
- » Locking Quick Release Throw Levers Prevent Inadvertent Release
- » Rated for .338 LAPUA Magnum
- » Squared Recoil Stops Prevent Forward and Rearward Movement under Recoil
- » Snag-free Radiused Edges and Corners and Melted Contours
- » Lightweight Skeletonized Matte Black Anodized Aluminum Construction

	AQR110	AQR115	AQR120	AQR310	AQR315	AQR322	AQR415	AQR420	AQR422	AQR432
Ring Type	Picatinny Rings (set of 2)									
Ring Diameter	1"	1"	1"	30 mm	30 mm	30 mm	34 mm	34 mm	34 mm	34 mm
Profile	Low	Medium	High	Low	Medium	High	Medium	High	X-High	2X-High
Max. Scope Outer Dia.	45.4 mm	55.4 mm	65.4 mm	50 mm	60 mm	74 mm	64 mm	74 mm	98 mm	98 mm
Center Height	22.7 mm	27.7 mm	32.7 mm	25 mm	30 mm	37 mm	32 mm	37 mm	39 mm	49 mm
Saddle Height	10 mm	15 mm	20 mm	10 mm	15 mm	22 mm	15 mm	20 mm	22 mm	32 mm
Ring Width	22 mm	22 mm	22 mm	22 mm	22 mm	22 mm	22 mm	22 mm	22 mm	22 mm





ACCU-SYNC® QR CANTILEVER MOUNTS

ACCU-SYNC® QR CANTILEVER MOUNTS

- » Tool-free and Wide-Range Tension Adjustment
- » Accommodates Even Most Out-of-spec Picatinny Rails
- » Locking Quick Release Throw Levers Prevent Inadvertent Release
- » Rated for .338 LAPUA Magnum
- » Squared Recoil Stops Prevent Forward and Rearward Movement under Recoil
- » Snag-free Radiused Edges and Corners and Melted Contours
- » Lightweight Skeletonized Matte Black Anodized Aluminum Construction



MEDIUM PROFILE
1 inch / AIR11834Q
1 inch / AIR11850Q

PICATINNY HIGH PROFILE
1 inch / AIR12250Q
30 mm / AIR32234Q
30 mm / AIR32250Q

X-HIGH PROFILE
34 mm / AIR42270Q



ACCU-SYNC® ANTI-CANT LEVELERS

- » Magnetic Flip-to-Side Anti-Cant Bubble Leveler Easily Seen Through Peripherals without having to Break Target Focus and/or Adjust Cheek Weld
- » Durable Matte Black Anodized 6061-T6 Aluminum Construction
- » Compatible with UTG® ACCU-SYNC® Cantilever Mounts and Rings that Feature a Mechanical Offset
- » US PAT. 1129372

1 inch / MT-RTR1
30 mm / MT-RTR3
34 mm / MT-RTR4



ACCU-SYNC® ANTI-CANT LEVELERS & MRDS MOUNTS

- » Magnetic Flip-to-Side Anti-Cant Bubble Leveler Easily Seen Through Peripherals without having to Break Target Focus and/or Adjust Cheek Weld
- » Durable Matte Black Anodized 6061-T6 Aluminum Construction
- » Compatible with UTG® ACCU-SYNC® Cantilever Mounts and Rings that Feature a Mechanical Offset
- » Includes Cover Plate and DOCTER® and RMR® Footprint Compatible Optic Plates
- » US PAT. 1129372

1 inch with MRDS Mounts / MT-RTF1
30 mm with MRDS Mounts / MT-RTF3
34 mm with MRDS Mounts / MT-RTF4

ACCU-SYNC® CANTILEVER RINGS & MOUNTS



PICATINNY CANTILEVER MOUNTS

MEDIUM PROFILE
1 inch / AIR11834
1 inch / AIR11850
30 mm / AIR31834
30 mm / AIR31850

HIGH PROFILE
1 inch / AIR12234
1 inch / AIR12250
30 mm / AIR32234
30 mm / AIR32250
34 mm / AIR42250



PICATINNY CANTILEVER SCOPE RINGS

HIGH PROFILE
1 inch / AIR122S
30 mm / AIR322S
34 mm / AIR422S

QR Matte Black	AIR11834Q	AIR11850Q		AIR12250Q			AIR32234Q	AIR32250Q		AIR42270Q			
Matte Black	AIR11834	AIR11850	AIR12234	AIR12250	AIR31834	AIR31850	AIR32234	AIR32250	AIR42250		AIR122S	AIR322S	AIR422S
AB=Matte Blue	AIR11834AB		AIR12234AB	AIR12250AB	AIR31834AB	AIR31850AB		AIR32250AB	AIR42250AB		AIR122SAB		
AR=Matte Red	AIR11834AR	AIR11850AR	AIR12234AR	AIR12250AR	AIR31834AR	AIR31850AR	AIR32234AR					AIR322SAR	AIR422SAR
Ring Type	Picatinny Cantilever Mount										Cantilever Scope Rings		
Ring Diameter	1"	1"	1"	1"	30 mm	30 mm	30 mm	30 mm	34 mm	34 mm	1"	30 mm	34 mm
Profile	Medium	Medium	High	High	Medium	Medium	High	High	High	X-High	High	High	High
Max. Scope Outer Dia.	61 mm	61 mm	69 mm	69 mm	65 mm	65 mm	73 mm	73 mm	77 mm	78 mm	69 mm	73 mm	77 mm
Center Height	31 mm	31 mm	35 mm	35 mm	33 mm	33 mm	37 mm	37 mm	39 mm	39 mm	35 mm	37 mm	39 mm
Saddle Height	18 mm	18 mm	22 mm	22 mm	18 mm	18 mm	22 mm	22 mm	22 mm	22 mm	22 mm	22 mm	22 mm
Ring Width	25 mm	25 mm	25 mm	25 mm	25 mm	25 mm	25 mm	25 mm	25 mm	25 mm	25 mm	25 mm	25 mm
Ring Distance	44 mm	60 mm	44 mm	60 mm	44 mm	60 mm	44 mm	60 mm	60 mm	60 mm	N/A	N/A	N/A
Integral Base Length	100 mm	100 mm	100 mm	100 mm	100 mm	100 mm	100 mm	100 mm	100 mm	100 mm	80 mm	32 mm	32 mm
Offset Distance	34 mm	50 mm	34 mm	50 mm	34 mm	50 mm	34 mm	50 mm	50 mm	70 mm	37 mm	37 mm	37 mm

UTG® SCOPE RINGS & MOUNTS



PICATINNY

- LOW PROFILE**
1 inch / RG2W1104
30 mm / RG2W3104
- MEDIUM PROFILE**
1 inch / RG2W1154
30 mm / RG2W3154
- HIGH PROFILE**
1 inch / RG2W1204
30 mm / RG2W3224



- LOW PROFILE**
1 inch / RGWM-25L2
30 mm / RGWM-30L4



PICATINNY

- MEDIUM PROFILE**
1 inch / RGWM-25M4
30 mm / RGWM-30M4
- HIGH PROFILE**
1 inch / RGWM-25H4
30 mm / RGWM-30H4



DOVETAIL

- MEDIUM PROFILE**
1 inch / RGPM-25M4
30 mm / RGPM-30M4
1 inch / RGPM2PA-25M4
30 mm / RGPM2PA-30M4
- HIGH PROFILE**
1 inch / RGPM-25H4
30 mm / RGPM-30H4
1 inch / RGPM2PA-25H4
30 mm / RGPM2PA-30H4
1 inch / RGPMOFS38-25H4

	RG2W1104	RG2W1154	RG2W1204	RG2W3104	RG2W3154	RG2W3224
Ring Type	QD Twist Lock Picatinny Scope Rings (set of 2)					
Ring Diameter	1"	1"	1"	30 mm	30 mm	30 mm
Profile	Low	Medium	High	Low	Medium	High
Max. Scope Outer Dia.	45 mm	55 mm	65 mm	49 mm	59 mm	73 mm
Center Height	23 mm	28 mm	33 mm	25 mm	30 mm	37 mm
Saddle Height	10 mm	15 mm	20 mm	10 mm	15 mm	22 mm
Ring Width	18 mm	22 mm	22 mm	22 mm	22 mm	22 mm

	RGWM-25L2	RGWM-25M4	RGWM-25H4	RGWM-30L4	RGWM-30M4	RGWM-30H4
Ring Type	Picatinny Scope Rings (set of 2)					
Ring Diameter	1"	1"	1"	30 mm	30 mm	30 mm
Profile	Low	Medium	High	Low	Medium	High
Max. Scope Outer Dia.	45 mm	53 mm	61 mm	47 mm	57 mm	73 mm
Center Height	23 mm	27 mm	31 mm	24 mm	29 mm	37 mm
Saddle Height	10 mm	14 mm	18 mm	9 mm	14 mm	22 mm
Ring Width	16 mm	21 mm	21 mm	21 mm	21 mm	21 mm

	RGPM-25M4	RGPM-25H4	RGPM-30M4	RGPM-30H4	RGPM2PA-25M4	RGPM2PA-25H4	RGPM2PA-30M4	RGPM2PA-30H4	RGPMOFS38-25H4
Ring Type	Dovetail Scope Rings (set of 2)				Dovetail Scope Ring Mounts				
Ring Diameter	1"	1"	30 mm	30 mm	1"	1"	30 mm	30 mm	1"
Profile	Medium	High	Medium	High	Medium	High	Medium	High	High
Max. Scope Outer Dia.	53 mm	67 mm	57 mm	71 mm	53 mm	67 mm	57 mm	71 mm	67 mm
Center Height	27 mm	34 mm	29 mm	36 mm	27 mm	34 mm	29 mm	36 mm	34 mm
Saddle Height	14 mm	21 mm	14 mm	21 mm	14 mm	21 mm	14 mm	21 mm	21 mm
Ring Width	21 mm	21 mm	21 mm	21 mm	21 mm	21 mm	21 mm	21 mm	21 mm
Ring Distance	N/A	N/A	N/A	N/A	58 mm	58 mm	58 mm	58 mm	39 mm
Integral Base Length	N/A	N/A	N/A	N/A	100 mm	100 mm	100 mm	100 mm	62 mm
Offset Distance	N/A	N/A	N/A	N/A	N/A	N/A	N/A	N/A	38 mm



DOVETAIL TO PICATINNY MOUNTS



DOVETAIL TO PICATINNY ADAPTOR MOUNT

- » Precision Machined from Aircraft Aluminum with a Matte Black Finish
- » 3.94" Scalloped 9 Slot Picatinny Rail with 0.59" Saddle Height
- » Compatible with Flat Receivers Equipped with 9mm-11mm Dovetail Rails
- » US PAT. D837330

■ / MNT-PMTOWL-A



UNIVERSAL DOVETAIL TO PICATINNY ADAPTOR

- » Precision Machined from Aircraft Aluminum with a Matte Black Finish
- » Compatible with 9mm - 11mm Flat or Rounded Dovetail Rails
- » US PAT. 10352656, EU PAT. EP3196588

■ / MNT-DTW145



COMPENSATION MOUNT FOR RWS DIANA AIR RIFLES

- » Precision Machined from Aircraft Aluminum with a Matte Black Finish
- » Compensation to Bring the POI (Point Of Impact) Up 10 Inches at 30 Yards

■ / MNT-DNT06



DOVETAIL-TO-PICATINNY SNAP-IN RAIL ADAPTOR

- » Converts Picatinny Mounts and Accessories to Dovetail
- » Spring-loaded Self-adjusting Width with Removable Stop Pin for Added Retention
- » Reliable Aluminum and Steel Construction
- » US PAT. 8752325, EU PAT. EP3196588

■ / MNT-DT2PW01 (Set Of 2)

DRILLED & TAPPED RECEIVER MOUNTS



OPTIC MOUNT FOR REMINGTON® 870™

- » Precision Machined from Aircraft Aluminum with a Matte Black Hard Coat Anodize
- » 6.1" Length with 14 Picatinny Slots
- » Low Profile with See Thru Design for Use of Front Bead Sight
- » Compatible with REMINGTON® 870™/1100™ with Drilled and Tapped Receiver

■ / MTU028SG



OPTIC MOUNT FOR MOSSBERG® 500®

- » Precision Machined from Aircraft Aluminum with a Matte Black Hard Coat Anodize
- » 5.5" Length with 13 Picatinny Slots
- » Low Profile See Thru Design Allows Use of Front Sight Bead
- » Compatible with MOSSBERG® Model 500® with Drilled and Tapped Receiver

■ / MTU029SG
 ■ / MNT-MB500T (Overseas Version)



OPTIC MOUNT FOR REMINGTON® 700®

- » Solid Steel Construction
- » Clearance Cut for Reliable Case Ejection

For REMINGTON® 700® Long Action Rifles / ■ / MNT-RM700
 For REMINGTON® 700® Short Action Rifles / ■ / MNT-RM700S



OPTIC MOUNT FOR RUGER® 10/22®

- » Precision Machined from Aircraft Aluminum with a Matte Black Hard Coat Anodize
- » 4.67" Length with 11 Picatinny Slots
- » Low Profile Design with U-cut for Weight Reduction
- » Compatible with RUGER® 10/22® with Drilled and Tapped Receiver

■ / MTU030T22

SHOTGUN SIDE SADDLE MOUNTS



OPTIC MOUNT FOR MOSSBERG® 500® / 590® / 590M®

- » Durable 6061-T6 Aluminum Construction Finished in a Matte Black Anodization
- » Removable 4-Capacity Shot Shell Carrier Included
- » MT-MB590: Compatible with 12 Gauge MOSSBERG® 500®/590® Shotguns
- » MT-MB590M: Compatible with 12 Gauge MOSSBERG® 590M® Mag-Fed Shotguns

For MOSSBERG® 500® / 590® / ■ / MT-MB590
 For MOSSBERG® 590M® ■ / MT-MB590M



OPTIC MOUNT FOR REMINGTON® 870™

- » Durable 6061-T6 Aluminum Construction Finished in a Matte Black Anodization
- » Removable 4-Capacity Shot Shell Carrier Included
- » Compatible with 12 Gauge REMINGTON® 870™ and 870 DM Shotguns with up to a 3.5" Chambering

■ / MT-RM870



DEDICATED OPTIC MOUNTS FOR OP3 MICRO

* Excludes OP3 Mini MICRO with RMSC Footprint *



LOW PROFILE DOVETAIL MOUNT
Dovetail /
0.33" Saddle Height / RDM-20XSD



45° ANGLE MOUNT
Picatinny /
RDM-2045



ABSOLUTE CO-WITNESS MOUNT
Picatinny /
0.78" Saddle Height / RDM-20AC



REAR SIGHT MOUNTS
For GLOCK® Dovetail /
0.15" Saddle Height / RDM-20GL



REAR SIGHT MOUNTS
For Sig P-Series Dovetail /
0.16" Saddle Height / RDM-20SIG



REAR SIGHT MOUNTS
For S&W M&P® Dovetail /
0.16" Saddle Height / RDM-20SW



OP3 MICRO MOUNTS						
	RDM-20XSD	RDM-2045	RDM-20AC	RDM-20GL	RDM-20SIG	RDM-20SW
Length / Width	1.8" / 1.1"	1.8" / 2.5"	1.8" / 1.1"	1.8" / 1.1"	1.8" / 1.1"	1.8" / 1.1"
Saddle Height	0.3"	N/A	0.78"	0.15"	0.16"	0.16"
Weight	21.3 oz	1.5 oz	1.5 oz	0.5 oz	0.5 oz	0.5 oz



OP3 MICRO MRDS

* Refer to P. 062 - P. 063 for More Info



OP3 MINI MICRO
Constant-on Automatic Brightness
SHIELD RMSC Footprint / Red 3 MOA / OT-RDM16R



OP3 MICRO
Manual Brightness
DOCTER® Footprint / Red 4 MOA / OP-RDM20R
DOCTER® Footprint / Green 4 MOA / OP-RDM20G
RMR® Footprint / Red 4 MOA / OP-RMR20R



OP3 MICRO SL
Side Loading Battery / Manual Brightness
DOCTER® Footprint / Red 4 MOA / OP-RDM20CT

OP3 MICRO SLS

Side Loading Battery / Manual & Auto Sensing Brightness
DOCTER® Footprint / Red 4 MOA / OP-RDM20CTS
RMR® Footprint / Red 4 MOA / OP-RMR20CTS

DEDICATED OPTIC MOUNTS FOR RMR® /T1 / MRO®

FOR TRIJICON RMR®



45° ANGLED MOUNT
Picatinny /
MT-RMR45



LOWER 1/3 CO-WITNESS MOUNT
Picatinny /
0.95" Saddle Height / MT-RMR13C



ABSOLUTE CO-WITNESS MOUNT
Picatinny /
0.87" Saddle Height / MT-RMRAC



2-IN-1 COMBO
/ MT-RMRKIT



LOW PROFILE MOUNT
Picatinny /
0.40" Saddle Height / MT-RMRXS



REAR SIGHT MOUNT
For GLOCK® Dovetail
/ 0.15" Saddle Height / MT-RMRGL

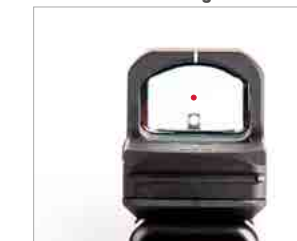

FOR AIMPOINT® T1



ABSOLUTE CO-WITNESS MOUNT
Picatinny /
0.78" Saddle Height / MT-T1AC



LOWER 1/3 CO-WITNESS MOUNT
Picatinny /
1.04" Saddle Height / MT-T113C



LOWER 1/3 CO-WITNESS MOUNT
Picatinny /
0.76" Saddle Height / MT-MRO13C



ABSOLUTE CO-WITNESS MOUNT
Picatinny /
0.65" Saddle Height / MT-MROAC



LOW PROFILE MOUNT
Picatinny /
0.20" Saddle Height / MT-MROXS

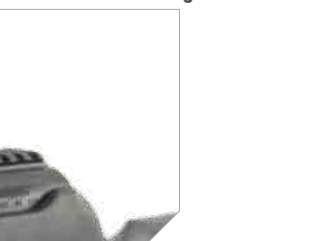

	MT-RMR45	MT-RMR13C	MT-RMRKIT		MT-RMRGL	MT-T1AC	MT-T113C	MT-MROAC	MT-MRO13C	MT-MROXS
			MT-RMRAC	MT-RMRXS						
Length / Width	1.8" / 2.5"	1.8" / 1.1"	1.8" / 1.1"	1.8" / 1.1"	1.8" / 1.1"	1.9" / 1.2"	1.9" / 1.2"	1.5" / 1.2"	1.5" / 1.2"	1.5" / 1.2"
Saddle Height	N/A	0.95"	0.87"	0.40"	0.16"	0.78"	1.04"	0.65"	0.76"	0.20"
Weight	1.4 oz	1.6 oz	1.5 oz	1.4 oz	0.4 oz	1.2 oz	1.3 oz	0.9 oz	0.9 oz	0.6 oz



AK RECEIVER MOUNTS



AK ACCU-SYNC® QUICK RELEASE SIDE MOUNT

- » Matte Black Anodized Steel-reinforced 6061-T6 Aluminum Construction
- » Tool-free, Tension-adjustable Steel Quick Release (QR) Lever Mount Compatible with Most Standard Receiver Side Rails
- » Universal, 16-slot Picatinny Top Rail, Centering with Receiver May Vary Depending on Make and Model and Manufacturing Tolerances
- » Overall Lightweight Design Features 2 Side M-LOK® Slots for Attaching Accessories
- » US PAT. D949276, US PAT. D949277

■ / MT-UAK01



AK QUICK DETACH SIDE MOUNT FOR ZASTAVA M70 N-PAP

- » Designed for the Zastava M70 N-PAP
- » Matte Black Anodized 6061-T6 Aluminum Construction
- » Adjustable Quick-detach Lever Mount
- » Scalloped 15 Slot Picatinny Rail Features a Deep U-cut Channel for Accessing Iron Sights
- » Overall Lightweight Design Features 2 Side M-LOK® Slots for Attaching Accessories
- » US PAT. D949276, US PAT. D949277

■ / MT-ZAK01



UTG PRO®

AK QUICK DETACH SIDE MOUNT

- » Proudly Designed and Made in USA with a Lifetime Warranty
- » Matte Black Anodized 6061-T6 Aluminum Construction
- » Lightweight Design with Deep U-Cut Channel for Accessing Iron Sights
- » 16 Slot Picatinny Top Rail with Detachable 6 Slot Side Rail
- » Tension Adjustable Quick Detach Lever Mount

■ / MTU016



AK STEEL SIDE PLATE

- » Durable Steel Construction with a Matte Black Finish
- » Fits Both Milled and Stamped AK Receivers and Accepts a Wide Variety of Side Optic Mounts
- » Permanent Modification Required

■ / TL-M47SR

PICATINNY RISERS



0.5 INCH

3-slot / MT-RSX5S
13-slot / MT-RSX5L

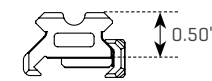

US PAT. D784482



0.75 INCH

3-slot / MT-RSX7S
13-slot / MT-RSX7L

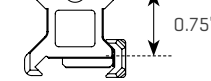

US PAT. D784483



0.83 INCH

3-slot / MT-RSX8S
13-slot / MT-RSX8L

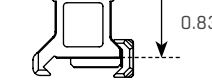

1 INCH

3-slot / MT-RSX1S
13-slot / MT-RSX1L1

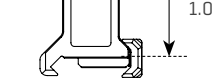

US PAT. D784481



20 MOA ELEVATED PICATINNY MOUNT

13-slot / MT-RSX20MOA

SUPER SLIM PICATINNY RISER MOUNTS

- » Matte Black Anodized 6061-T6 Aluminum Construction
- » Lightweight and Low Profile with Dehorned Corners and Melted Contours
- » Laser Engraved T-marked MIL-STD-1913 Picatinny Rail
- » Squared Integral Recoil Stops for a Secure and Repeatable Zero Hold
- » Significant Lightening Cuts Reduce Overall Weight and Bulk (Medium and High Profile Only)

	MT-RSX5S	MT-RSX7S	MT-RSX8S	MT-RSX1S	MT-RSX5L	MT-RSX7L	MT-RSX8L	MT-RSX1L	MT-RSX20MOA
Length	1.6"	1.6"	1.6"	1.6"	5.5"	5.5"	5.5"	5.5"	5.5"
Saddle Height	0.50"	0.75"	0.83"	1.00"	0.50"	0.75"	0.83"	1.00"	0.52"/0.55"
Picatinny Slots	3	3	3	3	13	13	13	13	13
Weight	0.9 oz	0.9 oz	1.0 oz	1.0 oz	2.7 oz	2.7 oz	2.8 oz	2.8 oz	2.7 oz



Utilizes Locking Torx Screws and Square-shaped Integral Recoil Stops for a Secure Zero Hold



Rail Slots Index Perfectly with Receiver Slots



Scalloped Picatinny Slots for Snag Free Accessory Mounting

IRON SIGHTS

TRIED AND TRUE.

Irons still have their place on modern day firearms. Regardless of the mainstream acceptance of running electronic primary and or secondary optics, iron sights remain effective and do well to combat Murphy's Law. Leapers iron sights are intuitive, minimalistic, and available in several different configurations. Your backup has arrived.



JUMP TO A SERIES

AR FLIP-UP SIGHTS

UTG PRO® Ultra Lite Sights [NEW]	086
UTG PRO® Flip-Up Sights	086
UTG® Super Slim Flip-Up Sights	088
UTG® ACCU-SYNC® Spring-Loaded Flip-Up Sights	088
UTG® ACCU-SYNC® 45° Flip-Up Sights	088

AR FIXED SIGHTS

Carry Handles	090
Super Slim Fixed Sights	091

[THIRD PARTY TRADEMARKS MAY BE USED IN THIS CATALOG FOR USER CONVENIENCE TO INDICATE THE FIT OR COMPATIBILITY OF THE APPLICABLE PRODUCT.]





UTG PRO® FLIP-UP SIGHTS

UTG PRO® 

ULTRA LITE FRONT SIGHT **NEW**

- » Proudly Designed and Made in USA
- » Lightweight Matte Gray Anodized Titanium Main Body with Black Nitrided Steel Components
- » Tool-free Elevation Adjustment
- » Manually Deployed, Standard AR Height, and Mounts to All MIL-STD-1913 Picatinny Rails
- » Steel Rectangular Front Sight Post, Reversible for Standard .06" and .04" Match Widths
- » Low profile 1.59" Length and .42" Height when Stowed
- » Squared Recoil Lugs and Optimized Sight Tower Detent for a Secure and Repeatable Zero
- » Lightweight at .98 oz.
- » Matches UTG PRO® Ultra Lite Rear Sight, TLURS56
- » Patent Pending

 / TLUF56



UTG PRO® 

ULTRA LITE REAR SIGHT **NEW**

- » Proudly Designed and Made in USA
- » Lightweight Matte Gray Anodized Titanium Main Body with Black Nitrided Steel Components
- » Manually Deployed, Standard AR Height, and Mounts to All MIL-STD-1913 Picatinny Rails
- » Tool-free Windage Adjustment with Reversible .07" and .20" Aperture, Serrated for Glare Reduction
- » Low profile 1.98" Length and .31" Height when Stowed, Fits Underneath Magnified Optics and Clears Most Charging Handles
- » Squared Recoil Lugs and Optimized Sight Tower Detent for a Secure and Repeatable Zero
- » Lightweight at .95 oz.
- » Patent Pending

 / TLURS56



UTG PRO® 

FLIP-UP FRONT SIGHT

- » Proudly Designed and Made in USA
- » Durable Aircraft Aluminum Construction with Reinforced Steel Components
- » Finished in a Durable Matte Black Anodization
- » Designed for the AR Platform and Fits Most Picatinny Rails
- » Utilizes Standard Elevation Adjustable A2 Front Sight Post
- » Manual Flip-up Sight Tower Locks into Place when Deployed, Unlocks via Spring-loaded Push Button, Low Profile 0.55" Stowed Height
- » Lightweight at 1.3 oz.

 / TLUF55



UTG PRO® 

FLIP-UP REAR SIGHT

- » Proudly Designed and Made in USA
- » Durable Aircraft Aluminum Construction with Reinforced Steel Components
- » Finished in a Durable Matte Black Anodization
- » Designed for the AR Platform and Fits Most Picatinny Rails
- » Dual Aperture Tool-free Windage Adjustment
- » Manual Flip-up Sight Tower Locks into Place when Deployed, Unlocks via Spring-loaded Push Button, Low Profile 0.55" Stowed Height
- » Lightweight at 1.52 oz.

 / TLURS55



AR FLIP-UP SIGHTS



SUPER SLIM FLIP-UP FRONT SIGHT

- » Aluminum/Steel Construction with a Matte Black Finish
- » Standard A2 Front Sight Post with Precise Elevation Adjustment
- » Low Profile 3mm Locking Bolt and Mounting Deck Securely Attaches to any Picatinny Rail, 0.55" Stowed Height

■ / MNT-755



SUPER SLIM FLIP-UP REAR SIGHT

- » Aluminum/Steel Construction with a Matte Black Finish
- » Dual Aperture Rear Sight with Tool-free Windage Adjustment Wheel
- » Low Profile 3mm Locking Bolt and Mounting Deck Securely Attaches to any Picatinny Rail, 0.55" Stowed Height

■ / MNT-955



ACCU-SYNC® SPRING-LOADED FLIP-UP FRONT SIGHT

- » Precision Machined from Aircraft Aluminum with a Matte Black Finish
- » Lightweight, Space Saving, Fold Over Design Uses Minimal Rail Space, 0.6" Stowed Height
- » Posi-lock Push Button Automatically Deploys the Spring Loaded Sight and Prevents Sight from Collapsing when Deployed
- » Utilizes a Single Locking Torx Screw and Squared Recoil Stops for a Secure Zero Hold and Return to Zero on Picatinny Rails
- » US PAT. 10119784, US PAT. D863490

■ / MNT-757



ACCU-SYNC® SPRING-LOADED FLIP-UP REAR SIGHT

- » Precision Machined from Aircraft Aluminum with a Matte Black Finish
- » Lightweight, Space Saving, Fold Over Design Uses Minimal Rail Space, 0.63" Stowed Height
- » Posi-lock Push Button Automatically Deploys the Spring Loaded Sight and Prevents Sight from Collapsing when Deployed
- » Dual Aperture Rear Sight with Tool-free Windage Adjustment Wheel
- » Utilizes a Single Locking Torx Screw and Squared Recoil Stops for a Secure Zero Hold and Return to Zero on Picatinny Rails
- » US PAT. 10119784, US PAT. D863489

■ / MNT-957



ACCU-SYNC® 45° FLIP-UP FRONT SIGHT

- » Precision Machined from Aircraft Aluminum with a Matte Black Finish
- » 45° Angled Offset Allows Access to Iron Sights Simultaneously with Primary Mounted Magnified Optics
- » Posi-lock Retention Plunger Locks Sight in Deployed Position
- » Tool-free Front Sight Post Elevation Adjustment Wheel
- » Utilizes a Single Locking Torx Screw and Squared Recoil stops for a Secure Zero Hold and Return to Zero on Picatinny Rails
- » US PAT. 10030935, US PAT. D851203

■ / MT-745



ACCU-SYNC® 45° FLIP-UP REAR SIGHT

- » Precision Machined from Aircraft Aluminum with a Matte Black Finish
- » 45° Angled Offset Allows Access to Iron Sights Simultaneously with Primary Mounted Magnified Optics
- » Posi-lock Retention Plunger Locks Sight in Deployed Position
- » Dual Aperture Rear Sight with Tool-free Windage Adjustment Wheel
- » Utilizes a Single Locking Torx Screw and Squared Recoil Stops for a Secure Zero Hold and Return to Zero on Picatinny Rails
- » US PAT. 10030935, US PAT. D852920

■ / MT-945



AR FIXED SIGHTS



UTG PRO  **FORGED 7075-T6 ALUMINUM**

MIL-SPEC FORGED CARRY HANDLE SIGHT

- » Mil-spec Match Grade Detachable Carry Handle with A2 Sight Assembly
- » Picatinny Mounting Base with Full Length Locking Plate and Dual Oversized Locking Thumb Wheels
- » Forged 7075-T6 Aluminum and Steel Construction Finished in a Matte Black Finish
- » Steel A2 Sight Assembly Provides Precise and Reliable Windage/Elevation Adjustment, Complete with Dual Aiming Apertures

■ / TLURS001



ENHANCED CARRY HANDLE REAR SIGHT

- » Utilizes a Full Length Two Point Locking Side Plate with Low Profile Thumb Wheels and Four Integral Recoil Stops to Ensure a Secure Zero Hold
- » CNC Machined 6061-T6 Aluminum and Steel Construction with a Matte Black Finish

■ / DEM / MT-950X



LOW PROFILE SUPER SLIM FRONT SIGHT

- » Low Profile Front Sight with Adjustable A2 Front Sight Post, Fits on Picatinny Handguard or High Profile Gas Block Levelled with Flat Top Upper Receiver
- » Utilizes a Locking Torx Screw Side Plate and Squared Recoil Stop to Ensure a Secure Zero Hold
- » CNC Machined 6061-T6 Aircraft Aluminum and Steel Construction with a Matte Black Finish

■ / MT-754X



HIGH PROFILE SUPER SLIM FRONT SIGHT

- » High Profile Front Sight with Adjustable A2 Front Sight Post, Fits Lowered Offset Picatinny Railed Gas Blocks
- » Utilizes a Locking Torx Screw Side Plate and Squared Recoil Stop to Ensure a Secure Zero Hold
- » CNC Machined 6061-T6 Aircraft Aluminum and Steel Construction with a Matte Black Finish

■ / MT-750X



SUPER SLIM REAR SIGHT

- » Precision CNC Machined 6061-T6 Aircraft Aluminum Base with Steel A2 Sight Assembly
- » Slim and Lightweight Profile with a Durable Wear Resistant Matte Black Finish
- » Tool-free Windage and Elevation Adjustment with Dual Apertures
- » Utilizes a Single Locking Torx Screw and Squared Recoil Stop for a Secure Zero Hold and Return to Zero on MIL-STD-1913 Picatinny Rails

■ / MT-950RS03



AR15 CARRY HANDLE RAIL MOUNT

- » 12 Scalloped Picatinny Slots Top Rail with Secondary Integral STANAG Mounting Base
- » CNC Machined 6061-T6 Aircraft Aluminum and Steel Construction with a Matte Black Finish
- » Allows Use of Iron Sights
- » Secured Via Locking Knurled Thumb Nut

■ / MNT-993

RECEIVERS

**UNCOMPROMISING
STANDARDS.**

Located in Livonia, Michigan, LEAPERS UTG PRO[®], is an advanced manufacturing facility comprised of world-class CNC machines, injection-molding machines, robotic automation, and in-house CERAKOTE[®]. Our capable manufacturing facility is known by many for our UTG PRO[®] line of handguards, stocks, and magazines. Next on the line? UTG PRO[®] billet receivers.

JUMP TO A SERIES

UTG PRO[®] AR15 STRIPPED AMBI RECEIVERS 096
[NEW]

Stripped Ambi Lower

Stripped Upper

Stripped Ambi Receiver Set

UTG PRO[®] AR15 STRIPPED RECEIVERS **[NEW]** 098

Stripped Lower

Stripped Upper

Stripped Receiver Set

(THIRD PARTY TRADEMARKS MAY BE USED IN THIS CATALOG FOR USER CONVENIENCE TO INDICATE THE FIT OR COMPATIBILITY OF THE APPLICABLE PRODUCT.)



MICHIGAN BORN RECEIVERS



UTG PRO®

AR RECEIVERS

Michigan made and designed from the ground up to provide shooters with functionality that benefits their skill set. UTG PRO® billet 7075-T6 receivers feature improved ergonomics, rigid reliability, parts commonality, and a lightweight overall design with melted geometry.

EASE OF INSTALLATION

Threaded pins and featuring a captured rear takedown spring and buffer detent.

RIGID RELIABILITY

Precision CNC machined from industry standard 7075-T6 billet aluminum and finished in type III class II matte black hard coat anodize.

WEIGHT REDUCTION

Material removed from viable areas without hindering reliability.

PARTS COMMONALITY

Compatible with standard and most aftermarket Handguards, LPKS, BCGS, FCGS, etc.

SHOOTER-FOCUSED ERGONOMICS

Overall melted receiver geometry reduces snag points and hot spots.

SHORTENED & FLARED MAG WELL

Shorter height for compatibility with most, if not all magazines and drums.

FIRMLY PLANTED INDEXING

Ambidextrous trigger finger swells in line with the Mag well's outer ledge and shortened Height provides a firm and deliberate trigger finger index.

AR15 STRIPPED AMBI RECEIVER



UTG PRO  **NEW**

AR15 STRIPPED AMBI RECEIVER

- » Proudly Designed and Made in USA
- » True Ambidextrous Lower with Left and Right Side Bolt Hold Open and Release
- » Matte Black Type III Class II Hard Coat Anodized 7075-T6 Billet Construction
- » Glove-friendly Oversized Trigger Guard
- » Fenced-in Magazine Release and Ambidextrous Trigger Finger Indexing Shelves
- » Shortened and Flared Mag Well Fully Compatible with Most Magazines and Drums
- » Threaded Steel Retention Pins and Set Screws, Zero Roll Pins Used in Assembly
- » High Tolerance Fitment with Optional Tensioning Screw Included
- » Compatible with Most Furniture, Fire Control Groups, Bolt Carrier Groups, and Parts Kits
- » Captured Rear Takedown Pin, Detent, and Spring
- » Captured Buffer Detent and Spring
- » Lightweight with Overall Melted Receiver Geometry
- » Upper Receiver Cut for M4 Feed Ramps
- » Additional Rear Picatinny Slot
- » Multi-caliber Marked

STRIPPED AMBI LOWER / FLR002
STRIPPED UPPER / FUR001
STRIPPED AMBI RECEIVER SET / FCR002



True Ambidextrous Lower with Right Side Bolt Hold Open and Release



Threaded Steel Retention Pins and Set Screws, Zero Roll Pins Used in Assembly



Fenced-in Magazine Release with Ambi. Trigger Finger Indexing Shelves



Captured Rear Takedown Pin and Buffer Detent Assembly



Shortened and Flared Magwell Compatible with Most Magazines and Drums



Lightweight with Overall Melted Receiver Geometry and Extra Picatinny Slot



Compatible with Most Furniture, FCGS, BCGs, and Parts Kits



Type III Class II Anodized 7075-T6 Billet Construction

AR15 STRIPPED RECEIVER



UTG PRO  **NEW**

AR15 STRIPPED RECEIVER

- » Proudly Designed and Made in USA
- » Matte Black Type III Class II Hard Coat Anodized 7075-T6 Billet Construction
- » Glove-friendly Oversized Trigger Guard
- » Fenced-in Magazine Release and Ambidextrous Trigger Finger Indexing Shelves
- » Shortened and Flared Mag Well Fully Compatible with Most Magazines and Drums
- » Threaded Steel Pins for Bolt Catch and Forward Assist
- » Threaded Steel Retention Pins and Set Screws, Zero Roll Pins Used in Assembly
- » Compatible with Most Furniture, Fire Control Groups, Bolt Carrier Groups, and Parts Kits
- » Captured Rear Takedown Pin, Detent, and Spring
- » Captured Buffer Detent and Spring
- » Lightweight with Overall Melted Receiver Geometry
- » Upper Receiver Cut for M4 Feed Ramps
- » Additional Rear Picatinny Slot
- » Multi-caliber Marked

STRIPPED LOWER / FLR001
STRIPPED UPPER / FUR001
STRIPPED RECEIVER SET / FCR001



Shortened and Flared Mag Well Compatible with Most Magazines and Drums



Optional Lower to Upper Tensioning Screw Included



Fenced-in Magazine Release with Ambi. Trigger Finger Indexing Shelves



Captured Rear Takedown Pin and Buffer Detent Assembly



Threaded Steel Retention Pins and Set Screws, Zero Roll Pins Used in Assembly



Lightweight with Overall Melted Receiver Geometry and Extra Picatinny Slot



Compatible with Most Furniture, FCGS, BCGs, and Parts Kits



Type III Class II Anodized 7075-T6 Billet Construction

HANDGUARDS

**FOR ALL YOUR RAIL
ESTATE NEEDS.**

Drop-in or free-float real estate available in multiple lengths and configurations. Laying out a long gun for a particular task or shooting discipline certainly involves selecting a handguard at one point. The particular wants out of a handguard vary from shooter to shooter, but most can all agree modularity is the name of the game. Being lightweight, easy to install, and with a solid lock up is a given. Our UTG PRO® Michigan made selection of handguards takes all of the above into account using quality materials and finishes at a price accessible to everyone. Mount up and run it.

JUMP TO A SERIES

FREE FLOAT HANDGUARDS

FORERUNNER	102
ARWEN	104
SUPER SLIM SD	106
ULTRA SLIM	108
SUPER SLIM	108

DROP-IN HANDGUARDS

AR15 Drop-in	110
AK Drop-in	112
RUGER PC Carbine Drop-in	113

(THIRD PARTY TRADEMARKS MAY BE USED IN THIS CATALOG FOR USER CONVENIENCE TO INDICATE THE FIT OR COMPATIBILITY OF THE APPLICABLE PRODUCT.)



FORERUNNER

FORERUNNER FREE FLOAT HANDGUARDS

UTG PRO® 

AR15 FORERUNNER FREE FLOAT M-LOK® HANDGUARDS

- » Precision Machined from 6061-T6 Aluminum and Finished in a Matte Black Anodization
- » Unique Patented Titanium Barrel Nut Requires Little to No Timing in Relation to the Gas Tube and Installation Screws
- » M-LOK® Slots on 3 Slot Tracks for Mounting Accessories
- » Handguard Features an Ergonomic Octagonal Profile and Machined Lightening Cuts Made Throughout with a 3-Slot Top Picatinny Rail Found at the Front and Rear
- » Integral Anti-rotation Tabs for Accurate Alignment with Upper Receiver and to Prevent Unintentional Handguard Rotation and Flex
- » Compatible with Left or Right Handed Standard Mil-Spec AR15 Upper Receivers
- » Includes M-LOK® Picatinny Rail Section, QD Sling Swivel Adaptor, Installation Hardware, and Barrel Nut Wrench
- » US PAT. 10670369



	5 INCH	7 INCH	10 INCH	14 INCH	15 INCH	17 INCH
	MTU049SPM	MTU044SPM	MTU045SPM	MTU046SPM	MTU047SPM	MTU048SPM
Actual Length	4.8"	6.8"	9.8"	13.8"	15.3"	17.3"
M-LOK® Slots	3 Full, 3 Half	13 Full	19 Full	25 Full, 7 Half	28 Full, 3 Half	31 Full, 7 Half
Top Picatinny Slots	6	6	6	6	6	6
Weight	4.6 oz	5.7 oz	7.3 oz	9.5 oz	10.3 oz	11.5 oz





ARWEN

ARWEN FREE FLOAT HANDGUARDS

UTG PRO 

AR15 ARWEN FREE FLOAT M-LOK® HANDGUARDS

- » Arwen meaning "Fair" in Welsh, is the Go-to UTG PRO® Handguard Series for Shooters Looking for a Fair Priced, yet Fully Featured Handguard with a Streamlined Look and Feel
- » Precision Machined from 6061-T6 Aluminum and Finished in a Matte Black Anodization
- » Unique Patented Steel Barrel Nut Requires Little to No Timing in Relation to the Gas Tube and Installation Screws and Furthermore, Does not Require a Proprietary Wrench for Installation
- » M-LOK® Slots at the 3, 6, and 9 O'clock Positions along with Additional 45 Degree M-LOK® Slots Located at the Front of the Handguard
- » Lightening Cuts Throughout the Handguard Keep Weight to a Minimum
- » Includes Installation Hardware and Barrel Nut Wrench
- » US PAT. 10670369

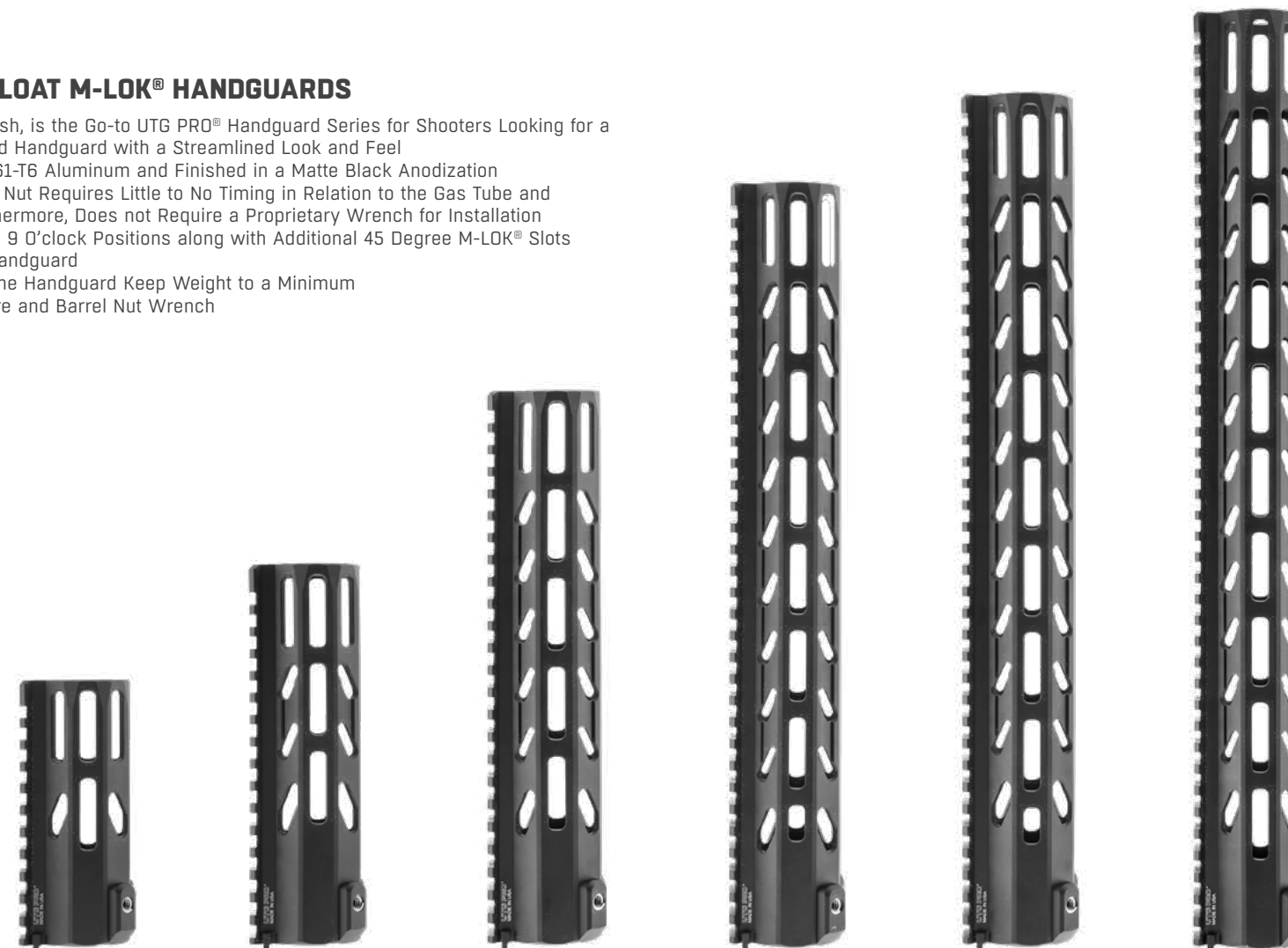

5 INCH

7 INCH

10 INCH

14 INCH

15 INCH

17 INCH

	MTU049SEM	MTU044SEM	MTU045SEM	MTU046SEM	MTU047SEM	MTU048SEM
Actual Length	4.8"	6.8"	9.8"	13.8"	15.3"	17.3"
M-LOK® Slots	10 Full	13 Full	19 Full	25 Full, 3 Half	28 Full, 3 Half	34 Full
Top Picatinny Slots	11	16	24	34	38	43
Weight	6.0 oz	7.4 oz	9.4 oz	12.1 oz	13.1 oz	14.4 oz



SUPER SLIM SD

SUPER SLIM SUPPRESSED FREE FLOAT HANDGUARDS

UTG PRO 

AR15 SUPER SLIM SD FREE FLOAT M-LOK® HANDGUARDS

- » 1.67" Inner Diameter for Compatibility with Suppressors
- » Precision Machined from 6061-T6 Aluminum and Finished in a Matte Black Anodization
- » M-LOK® Slots on 7 Slot Tracks for Mounting Accessories
- » Ergonomic Octagonal Profile with Grooved Surface Provides a Comfortable Means of Handling
- » Full Length Top Picatinny Rail is Flush and Continuous with Upper Receiver
- » Features Integral Anti-rotation Tabs for Accurate Alignment with Upper Receiver and to Prevent Unintentional Handguard Rotation and Flex
- » Compatible with Left or Right Handed Standard Mil-Spec AR15 Upper Receivers
- » Includes M-LOK® Picatinny Rail Section, QD Sling Swivel Adaptor, Installation Hardware, and Barrel Nut Wrench
- » US PAT. 10670369



7 INCH

	MTU044XLM
Actual Length	7"
M-LOK® Slots	21
Top Picatinny Slots	16
Weight	11.4 oz
Inner Diameter	1.67"



10 INCH

	MTU045XLM
Actual Length	10"
M-LOK® Slots	35
Top Picatinny Slots	24
Weight	13.7 oz
Inner Diameter	1.67"



14 INCH

	MTU046XLM
Actual Length	14"
M-LOK® Slots	49
Top Picatinny Slots	34
Weight	17.1 oz
Inner Diameter	1.67"



15.5 INCH

	MTU047XLM
Actual Length	15.5"
M-LOK® Slots	56
Top Picatinny Slots	38
Weight	18.3 oz
Inner Diameter	1.67"





ULTRA SLIM | SUPER SLIM

ULTRA SLIM & SUPER SLIM FREE FLOAT HANDGUARDS

UTG PRO 

AR15 ULTRA SLIM FREE FLOAT M-LOK® HANDGUARDS

- » Precision Machined from 6061-T6 Aluminum
- » Ultra Slim Design with Lightening Cuts Made Throughout, While Still Allowing for High Level of Modularity
- » Ergonomically Grooved Handguard Surface and Octagonal Profile Features Left and Right Side Grip Serrations
- » US PAT. 8806792



Compatible with Left or Right Handed Standard Mil-spec AR15 Upper Receivers

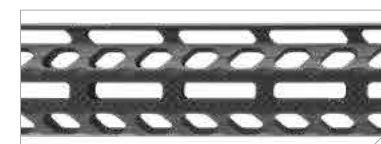

Left and Right Side Grip Serrations



Reduced Top End with 3-slot Picatinny Rail at the Front and Rear of Handguard

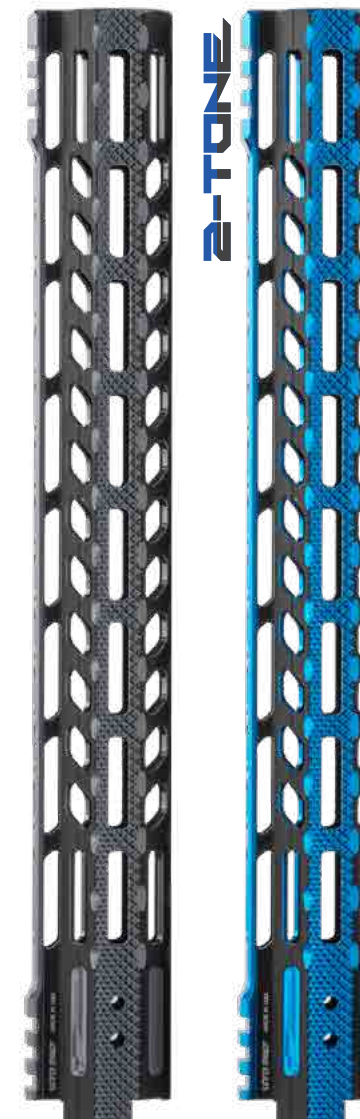

UTG PRO 

AR15 SUPER SLIM FREE FLOAT M-LOK® HANDGUARDS

- » Precision Machined from 6061-T6 Aluminum
- » Ergonomic Octagonal Profile with Grooved Surface for a Solid and Comfortable Grip
- » Scalloped Top Picatinny Rail Edges for Snag Free Accessories Mounting
- » Ergonomic Finger Grooves for a Solid and Comfortable Grip
- » Compatible with Right Handed Standard Mil-spec AR15 Upper Receivers Only
- » US PAT. 8806792









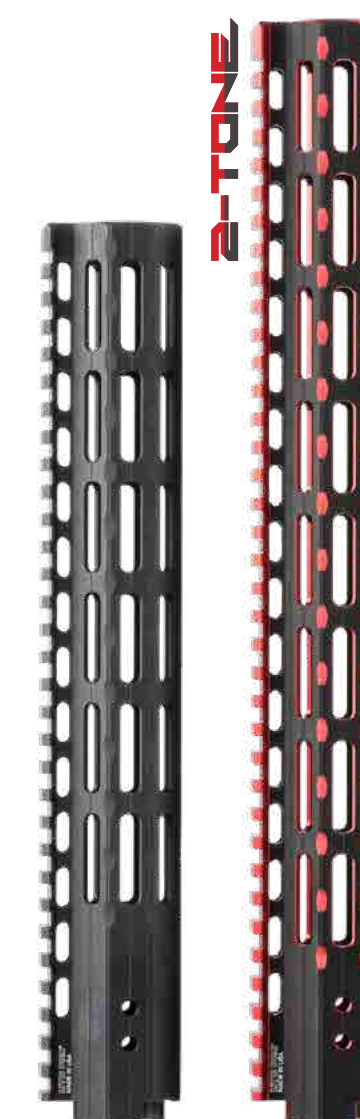

Flush Fitting and Continuous with Receiver



Integral Anti-rotation Tabs for Accurate Alignment with Receiver



	MTU019SSM3	MTU019SSM3B2	MTU019SSM3R2	MTU006SSM	MTU019SSM	MTU019SSMD	MTU019SSMB2	MTU019SSMR2	MTU019SSMZ2
	Ultra Slim			Super Slim					
Color	 Black	 Black/Blue	 Black/Red	 Black	 Black	 FDE Cerakote®	 Black/Blue	 Black/Red	 Black/Bronze
Length	15.3"	15.3"	15.3"	12.9"	15.3"	15.3"	15.3"	15.3"	15.3"
M-LOK® Slots	24	24	24	42	56	56	49	49	49
Picatinny Slots	6	6	6	31	37	37	37	37	37
Weight	11.5 oz	11.5 oz	11.5 oz	11.2 oz	12.5 oz	12.5 oz	12.8 oz	12.8 oz	12.8 oz



DROP-IN

DROP-IN HANDGUARDS



UTG PRO 

AR15 DROP-IN CARBINE LENGTH QUAD RAIL

- » Matte Black Anodized 6061-T6 Aluminum Construction
- » Two-piece Drop-in Design Requires no Permanent Modification
- » Compatible with Carbine-length DI Systems with Standard Delta Ring Assembly and Round Front Handguard Cap and the RUGER® AR-556®

■ / MTU001



UTG PRO 

AR15 DROP-IN CARBINE LENGTH QUAD RAIL WITH CONTINUOUS TOP RAIL

- » Matte Black Anodized 6061-T6 Aluminum Construction
- » Two-piece Drop-in Design Requires no Permanent Modification
- » Compatible with Carbine-length DI Systems with Standard Delta Ring Assembly and Round Front Handguard Cap and the RUGER® AR-556®

■ / MTU001T



UTG PRO 

AR15 DROP-IN MID-LENGTH QUAD RAIL

- » Matte Black Anodized 6061-T6 Aluminum Construction
- » Two-piece Drop-in Design Requires no Permanent Modification
- » Compatible with Mid-length DI Systems with Standard Delta Ring Assembly and Triangular Handguard Cap

■ / MTU007



US PAT. D851199

UTG PRO 

AR15 DROP-IN CARBINE LENGTH SUPER SLIM M-LOK® HANDGUARDS

- » Matte Black Anodized 6061-T6 Aluminum Construction
- » Two-piece Drop-in Design Requires no Permanent Modification
- » Compatible with Carbine-length DI Systems with Standard Delta Ring Assembly and Round Front Handguard Cap and the RUGER® AR-556®
- » Extended Top Rail Provides a Continuous Unimpeded Flat Top

■ / M-LOK® / MTU001SSM
■ / M-LOK® / MTU015SSM



US PAT. D851200

	MTU001	MTU001T	MTU007	MTU001SSM	MTU015SSM
Length	6.7"	7.3"	8.7"	7.3"	15.0"
Picatinny Slots	14	T:18 / B:17 / L:16 / R:16	18	18	31
Weight	11.3 oz	11.3 oz	14.7 oz	6.2 oz	12.4 oz





AK47/74 SUPER SLIM DROP-IN HANDGUARD



Modular Top End Mounts Included 9 Slot Picatinny Rail Section



DOCTER® Footprint MRDS Plate Included

UTG PRO® 922R COMPLIANT

AK47/74 SUPER SLIM DROP-IN M-LOK® HANDGUARD

- » Matte Black Anodized 6061-T6 Aluminum Construction
- » Compatible with Most Milled or Stamped Romanian, Chinese, and US AK47/AK74 Pattern Rifles
- » US PAT. 10962324

■ / M-LOK® / MTU053SSM

	MTU053SSM
Length / Width	6.20" / 1.61"
Height	2.63"
M-LOK® Slots	15
Weight	9.7 oz

AK DROP-IN QUAD RAIL HANDGUARDS

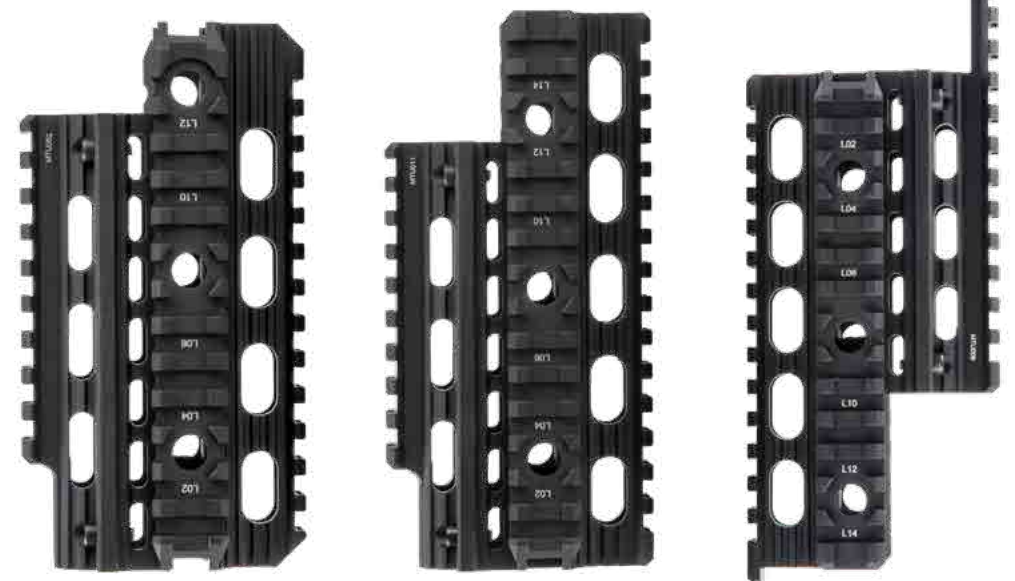

ZASTAVA M92 DROP-IN QUAD RAIL HANDGUARD

- » Designed Specifically for the Zastava M92

■ / MTU052

YUGO M70 AK QUAD RAIL HANDGUARD

- » Fits Yugo M70 Variants and is also compatible with the Zastava N-PAP after Removal of Rear Handguard Retainer

■ / MTU011

UNIVERSAL AK QUAD RAIL HANDGUARD

- » Compatible with Most Milled or Stamped Romanian, Chinese, and US AK47/AK74 Pattern Rifles

■ / MTU009

UTG PRO® 922R COMPLIANT

AK DROP-IN QUAD RAIL HANDGUARDS

- » Matte Black Anodized 6061-T6 Aluminum Construction
- » Lightening Cut MIL-STD-1913 Picatinny Quad Rail with Left/Right Integral QD Sling Swivel Housings
- » Two-piece Drop-in Design Requires No Permanent Modification

	MTU052	MTU011	MTU009
Length / Width	6.5" / 2.1"		8.4" / 2.1"
Top / Bottom / Left / Right Picatinny Slots	T:9 / B:15 / L:15 / R:15		T:14 / B:14 / L:14 / R:14
Weight	9.5 oz		9.2 oz

SUPER SLIM FOREND FOR RUGER® PC CARBINE™



Lower 1/3 Co-witness DOCTER® Footprint Optic Mount Included

UTG PRO®

SUPER SLIM M-LOK® FOREND FOR RUGER® PC CARBINE™

- » Matte Black Anodized 6061-T6 Aluminum Construction
- » Machined Lightening Cuts Throughout Forend Keep Weight to a Minimum
- » 8 M-LOK® Slots, 3 Slots at 3 and 9 O'clock and 2 Slots at 6 O'clock
- » Melted Contours, Chamfered Edges, and Dehorned Corners

■ / M-LOK® / MTU050SSM

	MTU050SSM
Length / Width	6.49" / 1.80"
Height	1.73" / 3.45" with MRDS Mount
M-LOK® Slots	8
Weight	9.3 oz



BIPODS

MAKE IT COUNT.

Purpose-built for every shooter. Whether recreational, competitive, and or professional we make a bipod with your name on it.

JUMP TO A SERIES

- | **UTG PRO® TBNR® BIPODS** 116
- | **BIG BORE FULL STABILITY BIPOD** 118
- | **OVER BORE BIPOD** 120
- | **RECON FLEX® BIPODS** 122
- | **RECON 360® TL BIPODS** 124
- | **D GRIP®** 126
- | **QUICK DETACH BIPODS** 127

(THIRD PARTY TRADEMARKS MAY BE USED IN THIS CATALOG FOR USER CONVENIENCE TO INDICATE THE FIT OR COMPATIBILITY OF THE APPLICABLE PRODUCT.)



THE BEST NEVER REST®



TBNR® BIPODS | THE BEST NEVER REST



M-LOK®

8.5" - 11.0" Center Height / TLUBP01M
7.3" - 9.0" Center Height / TLUBP02M-A

PICATINNY

8.5" - 11.0" Center Height / TLUBP01
7.3" - 9.1" Center Height / TLUBP02-A



OPTIONAL ACCESSORIES

QD ADJUSTABLE BIPOD FEET

- » Adjustable Rotary Turrets with Locking Collars Secure End User Height Adjustment
- » Compatible with UTG PRO® TBNR®, UTG® RECON FLEX® II, and Other QD Locking Detent Feet Bipods

1.65" - 1.93" Center Height / TL-BPLE01

UTG PRO® 

TBNR® BIPODS | THE BEST NEVER REST



Performance Tested and Evaluated

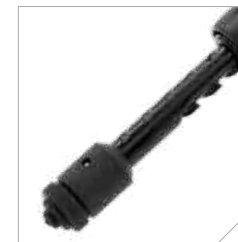

Height Adjustable Spiral Guided 7075-T6 Aluminum Leg Extensions with Automatic Leg Extension Retraction (US PAT. 10323897)



Tension Adjustable 360° Panning & 19° Tilt Forward, Rearward, Left, and Right



0°, 45°, & 90° Folding Leg Positions with Steel-on-steel Lockup

	TLUBP01M	TLUBP02M-A	TLUBP01	TLUBP02-A
Mount Type	M-LOK®		Picatinny	
Center Height	8.5" - 11.0"	7.3" - 9.0"	8.5" - 11.0"	7.3" - 9.1"
Open Angle	50°	50°	50°	50°
Panning	360°	360°	360°	360°
Tilting	19°	19°	19°	19°
Foot Pad	Aluminum			
Weight	19.0 oz	17.2 oz	19.7 oz	18.3 oz
Extendable Legs	7 Position	4 Position	7 Position	4 Position
Leg Operation	Spring Loaded Retraction			



BIG BORE FS

BIG BORE FULL STABILITY BIPOD



BIG BORE FULL STABILITY BIPOD

- » Matte Black Anodized Aluminum Construction with Reinforced Steel Components Designed from the Ground Up to Withstand Big Bore Calibers up to .50 BMG
- » Reinforced Picatinny Mounting Base Features a Longer Surface Area Equipped with a Squared Steel Crossbolt
- » Lockable and Height Adjustable Legs Provide a Center Height from 9"-14" and a Wide 70° Open Angle for Increased Stability
- » Posi-lock Push Buttons Feature a Large Surface Area for Easier Use while Wearing Gloves

9.4" - 14.0" Center Height / TL-BPFS01-A



0°, 45°, & 90° Folding Leg Positions with Steel-on-steel Lockup

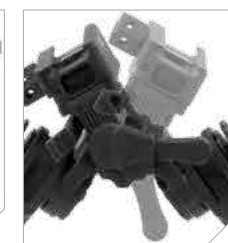

Tension Adjustable 35° Panning and 55° Left and Right Tilt



Rotatable Footpads Self Adjust to Uneven Surfaces and Bipod Leg Positioning

	TL-BPFS01-A
Mount Type	Picatinny
Center Height	9.4" - 14.0"
Open Angle	70°
Panning	35°
Tilting (Left/Right)	55°
Foot Pad	Steel
Weight	34.4 oz
Extendable Legs	9 Position
Leg Operation	Spring Loaded Retraction



OVER BORE

OVER BORE BIPOD



**RATED UP TO
.50 BMG**



OVER BORE BIPOD

- » Wide Open Angle Improves Stability
- » Matte Black Anodized Aircraft Aluminum Construction with Reinforced Steel Components
- » 3 Position Folding Legs Equipped with Rubberized Foot Pads
- » Lockable and Height Adjustable Legs Providing a Center Height from 7"-11"
- » 22° Panning and 44° Tension Adjustable Left and Right Tilt
- » Posi-lock Push Buttons Feature a Large Surface Area for Easier Use while Wearing Gloves

7.3" - 11.4" Center Height / TL-BPOB01-A



Quick Detachable Mounting Base (Designed to Mount Under or Over Rifle Bore)

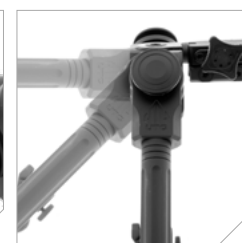

0°, 45°, & 90° Folding Leg Positions with Steel-on-steel Lockup



Oversized Posi-lock Push Buttons for Easier Use while Wearing Gloves



Tension Adjustable 44° Left & Right Tilt

	TL-BPOB01-A
Mount Type	Picatinny
Center Height	7.3" - 11.4"
Open Angle	70°
Panning	22°
Tilting (Left/Right)	44°
Foot Pad	Rubberized
Weight	24.1 oz
Extendable Legs	7 Position
Leg Operation	Spring Loaded Retraction



RECON FLEX®

RECON FLEX® BIPODS



RECON FLEX® II
 M-LOK® / 7.1" - 9.1" Center Height / TL-BPDM03
 M-LOK® / 8.7" - 12.0" Center Height / TL-BPDM04



RECON FLEX®
 M-LOK® / 5.7" - 8.0" Center Height / TL-BPDM01
 M-LOK® / 8.0" - 11.8" Center Height / TL-BPDM02
 KEYMOD / 5.7" - 8.0" Center Height / TL-BPDK01
 KEYMOD / 8.0" - 11.8" Center Height / TL-BPDK02



WWW.LEAPERS.COM | SINCE 1992

RECON FLEX® II BIPODS

- » 5 Position Bidirectional Legs Feature One-piece Locking Sliders with Circular Locking Lugs for Easier Manipulation and Added Durability
- » Interchangeable Foot Pads Compatible with Most Aftermarket Pads with QD Locking Detent
- » Automatic Leg Extension Deployment
- » Height Extendable Legs Lockable Via Thumb Wheel

RECON FLEX® BIPODS

- » Ergonomic Spring Loaded Slide Locking Ring for Quick and Effortless Bipod Deployment
- » Legs with 5 Posi-lock Positions for Use on Different Firearms with Varying Height Clearance and Mounting Real Estate
- » Height Extendable Legs Lockable Via Thumb Wheel
- » US PAT. 10295292



Directly Attaches to Handguard at the 3 and 9 O'clock Positions



5 Position Bidirectional Folding Legs

	TL-BPDM03	TL-BPDM04	TL-BPDM01	TL-BPDM02	TL-BPDK01	TL-BPDK02
Mount Type	M-LOK®			Keymod		
Center Height	7.1" - 9.1"	8.7" - 12.0"	5.7" - 8.0"	8.0" - 11.8"	5.7" - 8.0"	8.0" - 11.8"
Open Angle	50°	50°	50°	50°	50°	50°
Foot Pad	Rubberized					
Weight	11.3 oz / 2pcs	12.3 oz / 2pcs	10.8 oz / 2pcs	13.7 oz / 2pcs	10.8 oz / 2pcs	13.5 oz / 2pcs
Extendable Legs	5 Position	7 Position	5 Position	7 Position	5 Position	7 Position
Leg Operation	Spring Loaded Extension			Manual		





RECON 360®

RECON 360® BIPODS



M-LOK®

5.8" - 7.1" Center Height / TL-BPM02
 6.6" - 9.1" Center Height / TL-BPM01
 8.1" - 11.9" Center Height / TL-BPM03
 US PAT. D758522

PICATINNY

5.6" - 7.2" Center Height / TL-BP02-A
 6.6" - 9.1" Center Height / TL-BP01-A
 8.1" - 11.9" Center Height / TL-BP03-A
 US PAT. D758521, US PAT. D758522

WWW.LEAPERS.COM | SINCE 1992

RECON 360® TL BIPODS

- » Durable Aircraft Aluminum Construction Finished in a Matte Black Anodization
- » 3 Position Folding Legs and Lockable Leg Extensions Equipped with Nonslip Rubberized Foot Pads
- » Fine-tunable Tension Adjustment Lever Applies the User Desired Amount of Tension to the Bipod's 360° Panning & 15° Forward, Rearward, Left, and Right Tilt



0°, 45°, & 90° Folding Leg Positions



Fine-tunable Tension Adjustment Lever



15° Forward, Rearward, Left, and Right Tilt



360° Panning

	TL-BPM02	TL-BPM01	TL-BPM03	TL-BP02-A	TL-BP01-A	TL-BP03-A
Mount Type	M-LOK®			Picatinny		
Center Height	5.8" - 7.1"	6.6" - 9.1"	8.1" - 11.9"	5.6" - 7.2"	6.6" - 9.1"	8.1" - 11.9"
Open Angle	50°	50°	50°	50°	50°	50°
Panning	360°	360°	360°	360°	360°	360°
Tilting (Forward, Rearward, Left, & Right)	15°	15°	15°	15°	15°	15°
Foot Pad	Rubberized					
Weight	8.9 oz	11.3 oz	15.3 oz	10.9 oz	12.2 oz	14.5 oz
Extendable Legs	3 Position	5 Position	7 Position	3 Position	5 Position	7 Position
Leg Operation	Manual					





D GRIP®



D GRIP®

- » Contoured Foregrip with Nonslip and Heat-resistant Rubberized Inlays
- » Ambidextrous Quick Release Deploys Foldable Impact-resistant Bipod Legs Instantly
- » Quickly Transitions from Foregrip to Bipod
- » 5.6" Foregrip Length with an 8.4" Center Height and 65° Open Angle when Bipod is Deployed
- » US PAT. 8397421, US PAT. 9169958, EU REG: 002245522-0001, EU REG: 002245522-0002

/ MNT-DG02Q

	MNT-DG02Q
Mount Type	Picatinny
Center Height	8.4"
Open Angle	65°
Grip Height	5.6"
Bipod Height	8.6"
Foot Pad	Aluminum
Weight	12.7 oz
Leg Operation	Spring Loaded Deployment

QUICK DETACH BIPODS



RUBBER ARMORED QD BIPOD

- » Protected Rubber Armored Legs Stands up to the Harshes of Environments
- » 5 Position Extendable Legs Lockable via Thumb Wheel
- » 5 Position Bidirectional Folding Legs
- » US PAT. 8397421

QD Lever Lock / 6.0" - 8.5" Center Height / TL-BP20Q-A



TACTICAL OP BIPODS

- » Heavy Duty Steel and Aluminum Construction with a Matte Black Finish
- » Spring-loaded Folding Legs
- » Fully Adjustable Legs with Locking Thumb Wheel & Automatic Retraction
- » US PAT. 8397421

QD Lever Lock / 5.9" - 7.3" Center Height / TL-BP78Q
 QD Lever Lock / 8.0" - 12.4" Center Height / TL-BP88Q
 Locking Thumb Wheel / 6.1" - 7.9" Center Height / TL-BP78
 Locking Thumb Wheel / 8.3" - 12.7" Center Height / TL-BP88



SUPER DUTY QD BIPODS

- » Heavy Duty Steel and Aluminum Construction with a Matte Black Finish
- » Spring-loaded Folding Legs
- » Fully Adjustable Legs with Spring Loaded Retention Clamp and Locking Thumb Wheel
- » US PAT. 8397421

QD Lever Lock / 6.0" - 8.5" Center Height / TL-BP98Q
 QD Lever Lock / 8.0" - 12.8" Center Height / TL-BP99Q

OPTIONAL ACCESSORIES

SWIVEL STUD TO PICATINNY ADAPTOR

- » Steel and Aluminum Construction with Padded Adaptor Plate to Prevent Marring
- » Converts a Traditional Sling Swivel Stud to Accept Picatinny Mounted Bipods
- » Retains Swivel Stud Functionality for the Installation of a Sling when Installed
- » Quick to Install with No Permanent Modification Required

/ TL-BPAD1



QD ADJUSTABLE BIPOD FEET

- » Adjustable Rotary Turrets with Locking Collars Secure End User Height Adjustment
- » Compatible with UTG PRO® TBNR®, UTG® RECON FLEX® II, and Other QD Locking Detent Feet Bipods

1.65" - 1.93" Center Height / TL-BPLE01



	TL-BP20Q-A	TL-BP78Q	TL-BP88Q	TL-BP78	TL-BP88	TL-BP98Q	TL-BP99Q
Mount Type	Picatinny						
Center Height	6.0" - 8.5"	5.9" - 7.3"	8.0" - 12.4"	6.1" - 7.9"	8.3" - 12.7"	6.0" - 8.5"	8.0" - 12.8"
Open Angle	50°	50°	50°	50°	50°	50°	50°
Panning	15°	15°	15°	15°	15°	15°	15°
Foot Pad	Rubberized						
Weight	14.0 oz	13.0 oz	12.8 oz	11.5 oz	13.3 oz	13.8 oz	17.4 oz
Extendable Legs	5 Position	3 Position	7 Position	3 Position	7 Position	5 Position	9 Position
Foldable Legs	5 Position	Yes					
Swivel Stud Kit	Included						
Leg Operation	Manual	Spring Loaded Retraction				Manual	

STOCKS, BUFFERS & TUBES

ADD THE FINISHING TOUCH

You found and collected enough spare parts from deep within the confines of your basement to complete a lower parts kit and justifiably plan to build a complete rifle out of principle. Here is where you find everything needed to kit up your lower's stock assembly, finish the build and add it to the collection.

JUMP TO A SERIES

- | **AK SIDE FOLDER** **[NEW]** 130
- | **AR COLLAPSIBLE STOCKS** 132
 - S1 6-Position Stocks & Assemblies
 - S2 6-Position Stocks & Assemblies
 - S3 6-Position Stocks & Assemblies
 - S4 4-Position Stocks & Assemblies
 - U6 6-Position Stock Assemblies
- | **AR15 FIXED STOCKS** 134
- | **AR308 FIXED STOCK** 134
- | **TUBES & BUFFERS** 136

(THIRD PARTY TRADEMARKS MAY BE USED IN THIS CATALOG FOR USER CONVENIENCE TO INDICATE THE FIT OR COMPATIBILITY OF THE APPLICABLE PRODUCT.)





AK SIDE FOLDER



Right-side Folding



Five Position Settable LOP Adjustment

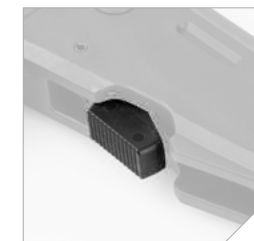

Spring-loaded LOP Deployment



Angled Nonslip Rubberized Recoil Pad

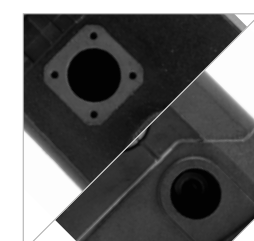

Quick Detach Sling Swivel Housings



Push-button Lockup

WWW.LEAPERS.COM | SINCE 1992

UTG PRO  **NEW**

AK SIDE FOLDER

- » Proudly Designed and Made in USA to fit Most Stamped AK Receivers
- » Right-side Folding with Positive Push-button Engagement and Lockup
- » Five Position Stock with Settable LOP Adjustment and Spring-loaded Deployment
- » Angled Nonslip Rubberized Recoil Pad
- » Reversible Quick Detach Sling Swivel Housing at Rear of Stock just Forward of Recoil Pad
- » Left Side Quick Detach Sling Swivel Housing at Front of Stock just Before Receiver
- » Impact & Heat Resistant Glass fiber-reinforced Matte Black Polymer Construction
- » Counts as One US Compliance Part for 922R

■ / Stock Only / RBU47FS01

Color	Black ■	RBU47FS01
Platform	Stamped AK with Straight Tang	Stock Assembly
Material	Polymer	
Dimensions	10.62" x 1.95" x 5.43"	
Weight	19.65 oz	





S-SERIES

COLLAPSIBLE STOCKS



S1 MIL-SPEC 6 POSITION STOCKS & ASSEMBLIES





- » Extended 8" Length for Increased Length of Pull

-  / Stock Assembly / RBUS1BM
-  / Stock Assembly / RBUS1DM
-  / Stock Only / RBUS1BMS
-  / Stock Only / RBUS1DMS



S2 MIL-SPEC 6 POSITION STOCKS & ASSEMBLIES





- » Lightweight Slim Profile with Extended 7.50" Length for Increased Length of Pull

-  / Stock Assembly / RBUS2BM
-  / Stock Assembly / RBUS2DM
-  / Stock Only / RBUS2BMS
-  / Stock Only / RBUS2DMS



S3 MIL-SPEC 6 POSITION STOCKS & ASSEMBLIES





- » Sub-compact Profile for Lightweight, Comfortable Performance
- » US PAT. D773005

-  / Stock Assembly / RBUS3BM
-  / Stock Assembly / RBUS3DM
-  / Stock Only / RBUS3BMS
-  / Stock Only / RBUS3DMS



S4 MIL-SPEC 4 POSITION STOCKS & ASSEMBLIES

- » Lightweight, Ultra Sub-compact Profile, Ideal for Compact Applications
- » Included Removable Cheek Rest for Improved Shooting Stability and Comfort
- » US PAT. D818074

-  / Stock Assembly / RBUS4BM
-  / Stock Assembly / RBUS4DM
-  / Stock Only / RBUS4BMS
-  / Stock Only / RBUS4DMS



U6 MIL-SPEC 6 POSITION STOCK ASSEMBLIES



- » Dual Standard Sling Loop Attachment Points
- » Lightweight Design with a Classic Look and Feel

-  / Stock Assembly / RBU6BM
-  / Stock Assembly / RBU6DM



COLLAPSIBLE STOCKS

- » Proudly Designed and Made in USA
- » Stock Molded from Impact Resistant High Strength Polymer
- » Built for Heavy Duty Use with the Tightest Tolerance Controls to Provide the Most Secure Fit and Function

	Black 	RBUS1BM	RBUS1BMS	RBUS2BM	RBUS2BMS	RBUS3BM	RBUS3BMS	RBUS4BM	RBUS4BMS	RBU6BM
	FDE 	RBUS1DM	RBUS1DMS	RBUS2DM	RBUS2DMS	RBUS3DM	RBUS3DMS	RBUS4DM	RBUS4DMS	RBU6DM
Type		Mil-spec	Mil-spec	Mil-spec	Mil-spec	Mil-spec	Mil-spec	Mil-spec	Mil-spec	Mil-spec
		Stock Assembly	Stock Only	Stock Assembly	Stock Only	Stock Assembly	Stock Only	Stock Assembly	Stock Only	Stock Assembly
Dimensions		8.5" x 2.3" x 5.5"		8.0" x 1.5" x 5.3"		6.1" x 1.5" x 4.8"		4.3" x 1.7" x 4.8"		6.9" x 1.7" x 5.2"
Weight		23.1 oz	12.6 oz	19.7 oz	9.9 oz	16.9 oz	7.0 oz	15.5 oz	5.7 oz	16.9 oz



FIXED STOCKS



S5 Fixed Stock Cheek Riser Included



Storage Compartment

UTG PRO

S5 FIXED STOCK

- » Proudly Designed and Made in USA
- » Stock Molded from Impact Resistant High Strength Matte Black Polymer
- » Built for Heavy Duty Use with the Tightest Tolerance Controls to Provide the Most Secure Fit and Function
- » Compatible with Rifle-length Receiver Extension Tube, Does Not Require A2 Buttstock Spacer
- » Overall Length with Ergonomic Slanted Cheek Rest and Steel Reinforced Rubberized Butt Pad
- » Integral Picatinny Rail Attaches Included 0.23" Cheek Riser and Other Accessories
- » Reversible Quick Detach Sling Swivel Housing for Left or Right Handed Shooters and Standard Sling Swivel Stud for Traditional Slings

 / AR / Stock Only / RBUS5BMS-A

A2 FIXED STOCK ASSEMBLIES

- » Stock Molded from Impact Resistant High Strength Polymer
- » (RB-T308FB) Compatible with ARMALITE® AR-10®, DPMS® LR-308, S&W M&P® 10, and Other Clones

 / AR15 / Stock Assembly / RB-T469B
 / AR308 / Stock Assembly / RB-T308FB

Black 	RBUS5BMS-A	RB-T469B	RB-T308FB
Platform	AR	AR15	AR308
	Stock Only	Stock Assembly	Stock Assembly
Dimensions	10.5" x 2.0" x 5.6"	10.8" x 1.6" x 5.1"	10.8" x 1.6" x 5.1"
Weight	14.8 oz	26.4 oz	25.5 oz







TUBES & BUFFERS



MIL-SPEC 6 POSITION RECEIVER EXTENSION TUBES & KITS

- » Extension Tube CNC Machined from 7075-T6 or 6061-T6 Aircraft Aluminum with Precisely Rolled Threads for Durable Thread Engagement with Lower Receiver
- » Tightest Tolerance Controls for a Secure Fit and Function with Various Collapsible Stocks
- » Finished in a Matte Black/Blue/Red/Bronze Hard Coat Anodization or FDE CERAKOTE®

Black 	TLU001-KIT	TLU001MS	TLU001
Red 			TLU001R
Blue 			TLU001B
FDE 	TLU001D-KIT		TLU001D
Bronze 			TLU001Z
Platform	AR15	AR15	AR15
Type	Mil-spec	Mil-spec	Mil-spec
	Tube Kit	Tube Only	Tube Only
Material	6061-T6	7075-T6	6061-T6
Dimensions	7.3" x 1.1" x 1.4"		
Weight	9.3 oz	4.0 oz	



CARBINE-LENGTH RECOIL BUFFERS

- » Potentially Increases Dwell Time, Eases Extraction, and Reduces Felt Recoil

H2 / 4.6 oz / RB-T6BFH2
H3 / 5.4 oz / RB-T6BFH3



AR PISTOL RECEIVER EXTENSION TUBE & KIT

- » 1.2" OD Receiver Extension Tube Compatible with AR15 Lower Receivers
- » Precision Machined from 7075-T6 Aircraft Aluminum with a Dry Film Lube Coated Interior for Smoother and More Reliable Cycling
- » Finished in a Matte Black Type III Class II Hard Coat Anodized Finish
- » Compatible with Standard AR15 Type Buffers and Springs
- » Compatible with Most AR Pistol Receiver Extension Tube Covers

 / Tube Only / TLU008
 / Tube Kit / TLU008-KIT



AR PISTOL EXTENDED RECEIVER EXTENSION TUBE & KIT

- » Precision Machined from 7075-T6 Aircraft Aluminum with a Dry Film Lube Coated Interior for Smoother and More Reliable Cycling
- » Finished in a Matte Black Type III Class II Hard Coat Anodized Finish
- » Compatible with Standard AR15 Type Buffers and Springs
- » 8.5" Extended Length and Compatible with GEAR HEAD WORKS® TAILHOOK™ MOD 1/1C Brace and or Most AR Pistol Receiver Extension Tube Covers

 / Tube Only / TLU009
 / Tube Kit / TLU009-KIT



A2 RECEIVER EXTENSION TUBE KIT

- » Rifle-length Extension Tube Precision Machined from 6061-T6 Aluminum and Finished in a Matte Black Anodization
- » Includes Rifle-length Extension Tube, Buffer, and Spring, A2 Stock Spacer, and Stock Screw

 / Tube Kit / TLT-A2KT

GRIPS & HAND STOPS

A MEANS OF CONTROL.

Ergonomics that fit like a glove and work with you not against. Take your pick from a various selection of impact resistant glass-fiber reinforced pistol grips, aluminum hand stops and foregrips, and other control components and tailor your rifle to a T.

JUMP TO A SERIES

PISTOL GRIPS 140

UTG PRO® Pistol Grips

Ultra Slim Pistol Grip

VERTICLE GRIPS 141

Ultra Slim Foregrips

Super Slim Aluminum Foregrips

Compact Polymer Foregrips

Aluminum QD Foldable Foregrip

D GRIP®

ULTRA SLIM ANGLED FOREGRIPS 142

HAND STOPS 143

Angled Index Mounts

Ultra Slim Hand Stops

Hand Stop / Barricade Rest

(THIRD PARTY TRADEMARKS MAY BE USED IN THIS CATALOG FOR USER CONVENIENCE TO INDICATE THE FIT OR COMPATIBILITY OF THE APPLICABLE PRODUCT.)





PISTOL GRIPS



UTG PRO 

AMBIDEXTRIOUS CONTOURED PISTOL GRIPS

- » Compatible with Most Ambidextrous Safety Levers
- » Ergonomic Finger Grooves with Nonslip Textured Grip Serrations Provide a Solid and Repeatable Grip
- » Ergonomic Symmetrical Palm Swells Reduce Fatigue and Improve Handling Comfort
- » Built-in Storage Compartment with Removable End Cap
- » Impact Resistant Polymer Construction

- / RBUPG01B
- / RBUPG01D



ULTRA SLIM PISTOL GRIP

- » Compatible with Most Ambidextrous Safeties
- » Nonslip Textured Front, Back, and Side to Side Grip Paneling
- » Impact Resistant Matte Black Polymer Construction
- » Built-in Grip Storage with Hinged Floor Plate

- / RBT-APG01B

VERTICAL GRIPS



ULTRA SLIM FOREGRIPS

- » CNC Machined from 6061-T6 Aluminum and Finished in a Matte Black Anodization
- » Mounts Bidirectionally and Features Two Different Ergonomically Serrated Contours to Choose From
- » Lightening Cuts Reduce Overall Weight

- / M-LOK® / MT-FGM01X
- / Picatinny / MT-FGP01X



COMPACT POLYMER FOREGRIPS

- » Impact Resistant Matte Black Polymer Construction
- » Nonslip Rubberized Grip Texture
- » Lightweight, Short, and Compact Profile

- / M-LOK® / RB-FGM01



ALUMINUM QD FOLDABLE FOREGRIP

- » Precision Machined from Aircraft Aluminum with a Matte Black Finish
- » Quick Detachable Picatinny Lever Lock Mounting Base
- » Posi-lock Cross Bolt and Spring Tensioned Locking Plate with Steel Insert for a Secure Installation
- » Removable End Cap with Waterproof Storage within Foregrip
- » Ergonomic Knurled Surface
- » US PAT. 8397421, US PAT. 8429843

- / Picatinny / MNT-GRP002SQ



SUPER SLIM ALUMINUM FOREGRIPS

- » Precision Machined from Aircraft Aluminum Finished in a Matte Black Anodization
- » Removable Red and Blue Anodized Inserts for M-LOK® and Keymod Models Adds a Level of Personalization
- » Slim, Lightweight, Ergonomic, with Dehorned Corners and Melted Contours for a Comfortable Support Hand Grip

- / M-LOK® / MT-FGM01
- / Picatinny / MT-FGP01
- / Keymod / MT-FGK01



D GRIP®

- » Contoured Foregrip with Nonslip and Heat-resistant Rubberized Inlays
- » Ambidextrous Quick Release Deploys Foldable Impact-resistant Bipod Legs Instantly
- » Quickly Transitions from Foregrip to Bipod
- » 5.6" Foregrip Length with an 8.4" Center Height and 65° Open Angle when Bipod is Deployed
- » US PAT. 8397421, US PAT. 9169958
- » EU REG: 002245522-0001, EU REG: 002245522-0002

- / Picatinny / MNT-DG02Q



ANGLED FOREGRIPS



- ULTRA SLIM ANGLED FOREGRIPS**
- » 6061-T6 Aluminum Construction Available in Matte Black, Blue, or Red Anodization, and Available for M-LOK®, Keymod, and Picatinny Modular Systems
 - » Weight Reduction Lightening Cuts, Ergonomic Contours, and Serrated Front, Bottom, and Rear Faces for Added Grip Retention
 - » Promotes Proper Support Hand Memory Placement and Retention
- | | | |
|----------------|----------------|------------------|
| M-LOK® | Keymod | Picatinny |
| ■ / MT-AFGM01 | ■ / MT-AFGK01 | ■ / MT-AFGP01 |
| ■ / MT-AFGM01B | ■ / MT-AFGK01B | |
| ■ / MT-AFGM01R | ■ / MT-AFGK01R | |

HAND STOPS



- ANGLED INDEX MOUNTS**
- » Precision Machined from 6061-T6 Aluminum and Finished in a Matte Black, Blue, or Red Anodization
 - » Provides an Additional Support Hand Indexing and Retention Point
 - » Reversible Design for Installation at the 3 or 9 O'clock Handguard Positions
 - » Compatible with the Majority of Octagonal Handguards
 - » Thumb Indexing Deck Configurable for Forward or Rearward Cant
 - » Spacer Included for Adjusting Clearance with 12 O'clock Mounted Accessories and Pressure Switches
 - » US PAT. 10612880
- | | |
|---------------|---------------|
| M-LOK® | Keymod |
| ■ / TL-TRM01 | ■ / TL-TRK01 |
| ■ / TL-TRM01B | ■ / TL-TRK01B |
| ■ / TL-TRM01R | ■ / TL-TRK01R |

- ULTRA SLIM HAND STOPS**
- » 6061-T6 Aluminum Construction Available in Matte Black, Blue, or Red Anodization for M-LOK® or Keymod Modular Systems
 - » Weight Reduction Lightening Cuts, Ergonomic Contours, and Serrated Front, Bottom, and Rear Faces for Added Grip Retention
 - » Promotes Proper Support Hand Memory Placement and Retention
- | | |
|---------------|---------------|
| M-LOK® | Keymod |
| ■ / TL-HSM01 | ■ / TL-HSK01 |
| ■ / TL-HSM01B | ■ / TL-HSK01B |
| ■ / TL-HSM01R | ■ / TL-HSK01R |

- KEYMOD HAND STOP/BARRICADE REST**
- » 6061-T6 Aircraft Aluminum Construction with a Matte Black Finish
 - » Compatible with UTG PRO® Super Slim AR15/AK Keymod Handguards
 - » Ergonomic Contour Improves Firearm Handling and Speeds Up Transitions
 - » Promotes Proper Support Hand Memory Placement and Retention
- | |
|---------------|
| Keymod |
| ■ / TL-HS02B |

MAGAZINES

YOU CAN NEVER HAVE ENOUGH.

Having underwent numerous rounds of fully loaded drop testing, live fire testing in the thousands, and reliably holding up to fully automatic rates of fire, Leapers has the steadfast reliability shooters require out of a magazine. Take your preference of windowed or non-windowed glass fiber reinforced construction that has been adverse temperature tested for reliable function before, during, and after.

JUMP TO A SERIES

AK/AKM POLYMER MAGAZINE [NEW] 146

7.62 X 39 mm / 30 Round / Windowed

AR POLYMER MAGAZINES 148

5.56 / 10 Round

5.56 / 30 Round / Windowed

5.56 / 30 Round

.308 / 25 Round / Windowed

POLYMER MAGAZINES FOR GLOCK 150

9 mm / 15 Round

9 mm / 17 Round

9 mm / 33 Round

9 mm / 33 Round / Windowed

(THIRD PARTY TRADEMARKS MAY BE USED IN THIS CATALOG FOR USER CONVENIENCE TO INDICATE THE FIT OR COMPATIBILITY OF THE APPLICABLE PRODUCT.)



AK/AKM POLYMER MAGAZINE



Steel-reinforced Feed Lips and Locking Lugs

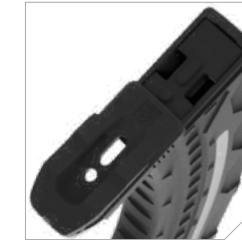

Removable Flared Floor Plate



Ambidextrous Windowed Main Body



High Visibility Blue Follower and Stainless Steel Spring



Raised Bosses for Added Grip Retention



Impact & Heat Resistant Reinforced Polymer



7.62 X 39 MM | 30 ROUND | WINDOWED

■ / RBT-AKM30

AK POLYMER MAGAZINE **NEW**

- » Durable Impact Resistant Glass fiber-reinforced Matte Black Polymer Construction
- » Steel-reinforced Feed Lips and Locking Lugs
- » Reliable Feed High Visibility Blue Follower and Stainless Steel Spring
- » 30 Round Capacity with Left and Right Side Co-molded Polymer Windows and Debossed Round Count Indicators
- » Raised Bosses for Added Grip Retention
- » Easy Disassembly and Maintenance with Removable Flared Floor Plate
- » US PAT. D849178





AR POLYMER MAGAZINES



5.56 | 10 ROUND
 ■ / RBT-AM10



UTG PRO®
 5.56 | 30 ROUND
 ■ / RBUAM01



5.56 | 30 ROUND | WINDOWED
 ■ / RBT-AM30



.308 | 25 ROUND | WINDOWED
 ■ / RBT-DM25

POLYMER MAGAZINES

- » Durable and Impact Resistant Glass Fiber Reinforced Matte Black Polymer Construction
- » Anti-tilt High Visibility Blue Follower and High Longevity Stainless Steel Spring for Reliable Feeding
- » Easy Disassembly and Maintenance with Removable Flared Floor Plate
- » US PAT. D849178



Four-way Anti-tilt High Visibility Blue Follower and High Longevity Stainless Steel Spring for Reliable Feeding



Removable Flared Floor Plate



Fully Automatic Torture Tested



Adverse -40°F to 160°F Temperature Tested



Drop Tested



POLYMER MAGAZINES FOR GLOCK®



9 MM | 15 ROUND
■ / RBT-GL915



9 MM | 17 ROUND
■ / RBT-GL917



9 MM | 33 ROUND
■ / RBT-GL933



9 MM | 33 ROUND | WINDOWED
■ / RBT-PD933
PAT. PENDING

POLYMER MAGAZINES FOR GLOCK®

- » Durable and Impact Resistant Glass Fiber Reinforced Matte Black Polymer Construction
- » Anti-tilt High Visibility Blue Follower and High Longevity Stainless Steel Spring for Reliable Feeding
- » Left and Right Side Capacity Indicators
- » Easy Disassembly and Maintenance with Removable Flared Floor Plate
- » Compatible with Reversible Magazine Release for Left or Right-handed Users



High Contrast Blue Anti-tilt Follower



Live Fire Torture Tested



Adverse Temperature Tested



Drop Tested

FLASHLIGHTS & LASERS

IDENTIFY WITH CERTAINTY.

It is critical to positively identify your target and what is behind it and within the immediate area. Assess and proceed accordingly with mounted and handheld solutions or ideally both for the most uncertain of times and situations. Two is one and one is none.



JUMP TO A SERIES

HANDHELD LIGHTS 154

Everyday Carry Flashlight
VANQUISH 700 Flashlight

WEAPON LIGHTS 155

Sub-compact Pistol Light
Compact Pistol Light
Quick Detach Grip Light
Polymer Grip Light

LASERS 156

BULLDOT® Compact Green Laser
Compact Green Pistol Laser
Compact Red Laser
Sub-compact Red Laser

FLASHLIGHT & LASER ACCESSORIES 157

(THIRD PARTY TRADEMARKS MAY BE USED IN THIS CATALOG FOR USER CONVENIENCE TO INDICATE THE FIT OR COMPATIBILITY OF THE APPLICABLE PRODUCT.)



HANDHELD LIGHTS

EVERYDAY CARRY FLASHLIGHT

- » Multi-functional Flood Focus: 400 Lumen and 20 Lumen High and Low Output with High Output Emergency SOS and Strobe
- » Momentary/Constant On/Off Push Button Tail Cap
- » Matte Black Anodized Aluminum Construction
- » Reversible Steel Pocket Clip for Bezel Head Up or Down Carry
- » IPX7 Waterproof Rated

■ / **LT-ELEDC01**



	LT-ELEDC01
Mount Type	Handheld / Pocket Clip
Lumen Output	High - 400 Lumen Low - 20 Lumen
Dimensions	4.72" x 1.10" (120 mm x 28 mm)
Weight (w/Battery)	4.3 oz (121.9 g)
Bulb Type	20 mm LED IRB
Focus	Preset Flood
Battery	CR123A x 2 (Also compatible with 18650 rechargeable battery)
Battery Life	High - 50 mins Low - 24 hrs

VANQUISH 700 FLASHLIGHT

- » Multi-functional Hybrid Focus: 700 Lumen and 20 Lumen High and Low Output with High Output Emergency Strobe
- » Force Multiplier Serrated Bezel Head
- » Momentary/Constant On/Off Push Button Tail Cap
- » Removable Grip Retention Insert and Spacer, Offset Picatinny Ring Mount, and Pressure Switch Included
- » Supports CR123A and Rechargeable 18650 Batteries
- » IPX7 Waterproof Rated
- » Matte Black Anodized Aluminum Construction

■ / **LT-EL700**

	LT-EL700
Mount Type	Handheld / Picatinny
Lumen Output	High - 700 Lumen Low - 20 Lumen
Dimensions	6.7" x 1.81" (170 mm x 46 mm)
Weight (w/Battery)	8.2 oz (233.9 g)
Bulb Type	37 mm LED IRB
Focus	Hybrid Beam with Large Spill Area & Intense Long Range Hotspot
Battery	CR123A x 2 (Also compatible with 18650 rechargeable battery)
Battery Life	High - 3 hrs Low - 24 hrs

WEAPON LIGHTS

SUB-COMPACT PISTOL LIGHT

- » Fits Flush on Most Compact Pistols
- » Ambidextrous Momentary/Constant On/Off Switches
- » Flood Focus 200 Lumen Beam
- » Matte Black Anodized Aluminum Construction
- » IPX7 Waterproof Rated

■ / **LT-ELP120R**

COMPACT PISTOL LIGHT

- » Ambidextrous Momentary/Constant On/Off Switches
- » Removable Positional Inserts Increase Pistol Rail Compatibility
- » Flood Focus 400 Lumen Beam
- » Matte Black Anodized Aluminum Construction

■ / **LT-ELP123R-A**

QUICK DETACH GRIP LIGHT

- » Momentary Constant On/Off Push Button
- » Flood Focus 400 Lumen Beam
- » Matte black Anodized Aluminum Construction
- » Picatinny Quick Detach Lever Lock Mount
- » US PAT. 8397421

■ / **MNT-EL228GPQ-A**

POLYMER GRIP LIGHT

- » Momentary/Constant On/Off Push Button
- » Left and Right Side Toggled Momentary Only Strobe
- » Flood Focus 400 Lumen Beam, Scalable in Constant-on from 400 to 20 Lumen
- » IPX7 Waterproof Rated
- » Impact Resistant Polymer Construction
- » US PAT. D876572

■ / **MT-EL223GX**

	LT-ELP120R	LT-ELP123R-A	MNT-EL228GPQ-A	MT-EL223GX
Mount Type	Picatinny	Picatinny	Picatinny QD Lever Lock	Picatinny
Lumen Output	200 Lumen	400 Lumen	400 Lumen	High-400 Lumen Low-20 Lumen
Dimensions	2.98" x 1.12" x 1.13" (75.8 mm x 28.5 mm x 28.7 mm)	3.11" x 1.31" x 1.50" (79 mm x 33.3 mm x 38 mm)	2.80" x 1.77" x 5.34" (71 mm x 45.8 mm x 135.7 mm)	2.13" x 1.38" x 4.09" (54.1 mm x 35.1 mm x 103.9 mm)
Weight (w/Battery)	2.6 oz (73 g)	3.5 oz (100.2 g)	12 oz (340.2 g)	6.6 oz (187.1 g)
Bulb Type	20 mm LED IRB	24 mm LED IRB	26 mm LED IRB	23 mm LED IRB
Focus	Preset Flood	Preset Flood	Wide Angled Flood	Wide Angled Flood
Battery	CR2 x 1	CR2 x 1	CR123A x 2	CR123A x 2
Battery Life	1 hr	1 hr	3 hrs	High - 3 hrs Low - 24 hrs



LASERS

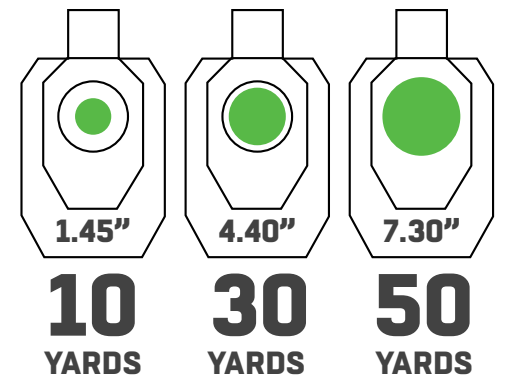

BULLDOT® COMPACT GREEN LASER

- » Expanding Beam Diameter Increases from 1" up to 8" at 50 Yards for the Eyes to Pick up Faster at Farther Distances
- » Matte Black Anodized Aluminum Construction
- » Constant On/Off Push Button Tail Cap and Pressure Switch Included

■ / SCP-LS289S

	SCP-LS289S
Mount Type	Low Profile Picatinny Mount
Laser Range	328.1 yds (300 m)
Beam Diameter	1.3" (32 mm) @ 10 yds (9.1 m) 3.8" (96 mm) @ 30 yds (27.4 m) 8" (203 mm) @ 50 yds (45.7 m)
Dimensions	3.37" x 1.89" x 1.34" (85.5 mm x 48 mm x 34 mm)
Weight with Battery	5.2 oz (133 g)
Battery	CR2 x 1



COMPACT GREEN PISTOL LASER

- » Fits Flush on Most Compact Pistols
- » Class 3R Bright Green Laser
- » Ambidextrous Momentary/Constant On/Off Switches
- » Matte Black Anodized Aluminum Construction
- » Low Profile Picatinny Mount and Side Plate

■ / SCP-LS279S-A



COMPACT RED LASER

- » Precise Windage / Elevation Adjustment
- » Powerful Long Range Beam with Pinpoint Accuracy
- » Pressure Switch Included
- » Slide-on Picatinny Ring Mount included

■ / SCP-LS268

	SCP-LS279S-A
Mount Type	Low Profile Picatinny Mount
Laser Range	546.8 yds (500 m)
Beam Diameter	1.1" (28 mm) @ 16.4 yds (15 m)
Dimensions	2.38" x 1.18" x 1.15" (60.4 mm x 30 mm x 29.3 mm)
Weight with Battery	2.1 oz (61 g)
Battery	1/3N x 1

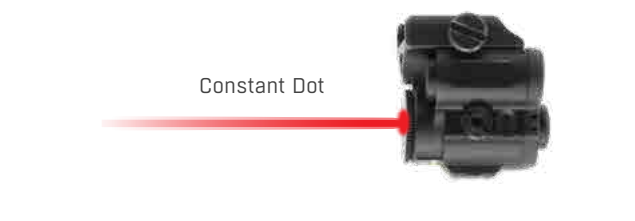
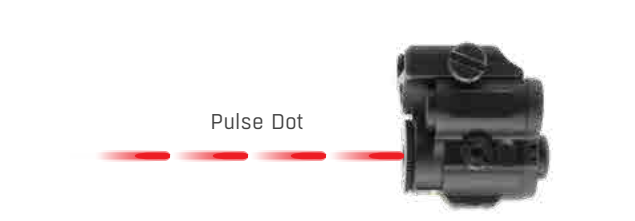

SUB-COMPACT RED LASER

- » Class 3R Bright Red Laser
- » Programmable for Constant or Pulse Dot Beam Operation
- » Matte Black Anodized Aluminum Construction
- » Sub-compact 1.19" Length
- » Low Profile Picatinny Mount and Side Plate

■ / SCP-LS200

	SCP-LS200
Mount Type	Low Profile Picatinny Mount
Laser Range	546.8 yds (500 m)
Beam Diameter	1.1" (28 mm) @ 16.4 yds (15 m)
Dimensions	1.19" x 1.27" x 1.28" (30.2 mm x 32.2 mm x 32.5 mm)
Weight with Battery	1.3 oz (36 g)
Battery	LR48 (AG5) x 4

OPTIONAL ACCESSORIES

PICATINNY OFFSET RING MOUNT

- » Compatible with 27mm, 25.4mm (1"), and 20mm Flashlight Body Diameters with Use of Included Inserts
- » Matte Black Anodized Aluminum Construction

■ / RG-FL138



M-LOK® / KEYMOD OFFSET RING MOUNTS

- » Snag-free Melted Contours and Dehorned Corners
- » Matte Black Anodized Aluminum Construction
- » Compatible with 27mm, 25.4mm (1"), and 20mm Body Diameters with Use of Included Inserts

■ / RG-FL27MC
■ / RG-FL27KC



	RG-FL138	RG-FL27MC	RG-FL27KC
Ring Diameter	Adaptable with Inserts		
No Insert (27 mm)	No Insert		
Insert 2 (25.4 mm)			
Compatible Model	LT-ELEDC01, LT-EL700		
Insert 1 + Insert 2 (20 mm)			

ACCESSORIES & TOOLS

UP FOR THE TASK AT HAND.

Range bag essentials. Work bench must-haves. Tools of the trade. Even small odds and ends you end up identifying a need for to get your rifle feeling and equipped just right.

JUMP TO A SERIES

AR ACCESSORIES	160
Oversized Bolt Catch	
Ambidextrous 45/90 Safety Selectors	
Oversized Trigger Guards	
Ambidextrous Extended Magazine Releases	
Quick Install Dust Cover	
CZ SCORPION ACCESSORIES	161
Charging Handles	
Safety Selectors	
MUZZLE DEVICES & GAS BLOCKS	162
QD SLING SWIVELS & ADAPTORS	163
RAIL SECTIONS & COVERS	164
TOOLS & MAINTENANCE	165

(THIRD PARTY TRADEMARKS MAY BE USED IN THIS CATALOG FOR USER CONVENIENCE TO INDICATE THE FIT OR COMPATIBILITY OF THE APPLICABLE PRODUCT.)





AR ACCESSORIES

AR15 LOWER UPGRADE KIT

■ / TLT-TKS01



OVERSIZED BOLT CATCH

- » Serrated and Oversized Bolt Release and Extended Catch for Easier Reach and Manipulation
- » Steel Construction Finished in Matte Black Anodization
- » Includes Installation Hardware



■ / TLT-TKSBC

AMBIDEXTROUS 45/90 SAFETY SELECTOR

- » Reversible Short and Long Oversized Levers Finished in a Matte Anodization
- » Aluminum and Steel Construction
- » 45° or 90° Throw Configurable
- » Includes Installation Tool, Hardware, Detent, and Detent Spring



■ / TLT-TKSLT
 ■ / TLT-TKSLTB
 ■ / TLT-TKSLTR

OVERSIZED TRIGGER GUARD

- » Enlarged Open Geometry Provides Easier and Safer Access to Trigger Particularly when Wearing Gloves
- » Aluminum Construction Finished in Matte Anodization
- » Includes Installation Tool and Hardware



■ / TLT-TKSTG
 ■ / TLT-TKSTGB
 ■ / TLT-TKSTGR

AMBIDEXTROUS EXTENDED MAGAZINE RELEASE

- » Features Oversized and Extended Left and Right Side Releases for Easier Reach and Manipulation
- » Aluminum and Steel Construction Finished in Matte Anodization
- » Includes Installation Tool and Hardware



■ / TLT-TKSMR
 ■ / TLT-TKSMRB
 ■ / TLT-TKSMRR

QUICK INSTALL DUST COVER

- » Matte Black Impact and Heat Resistant Polymer Construction with Steel Spring-loaded Detent
- » Patented Tool-free Design Quickly Installs Without Having to Remove The Handguard Prior
- » Compatible with all .223/5.56 Mil-spec. and Most Billet Upper Receivers
- » US PAT. 10393467



■ / RBT-TKSDC

CZ® SCORPION ACCESSORIES



CHARGING HANDLE FOR CZ® SCORPION™ EVO 3

- » Reversible for Left or Right Side Drop-in Installation
- » Extended and Partially Serrated Handle with Dehorned Corners and Melted Contours
- » Steel Guide with 6061-T6 Aluminum Handle Finished in a Matte Black, Red, or Blue Anodization
- » Compatible with Both Pistol and Carbine Models

■ / TLT-CSCH01
 ■ / TLT-CSCH01B
 ■ / TLT-CSCH01R



SAFETY SELECTORS FOR CZ® SCORPION™ EVO 3

- » Machined from 6061-T6 Aluminum Finished in a Matte Black, Red, or Blue Anodization
- » Drop-in Installation, No Permanent Modification Required
- » Compatible with Both Pistol and Carbine Models
- » Extended and Partially Serrated Selectors with Dehorned Corners and Melted Contours
- » Ergonomic Thumb Index for Ease of Manipulating Safety On and Off

■ / TLT-CSSLT01
 ■ / TLT-CSSLT01B
 ■ / TLT-CSSLT01R



MUZZLE DEVICES & GAS BLOCKS



MUZZLE BRAKES

- » Steel Construction Finished in Black Nitride
- » 1/2"-28 UNEF Thread Compatible, Crush Washer Included
- » Gas Dispersion Porting Reduces Felt Recoil and Muzzle Rise
- » Up to 50% Recoil Reduction



9 MM | 1/2"X28
■ / TLUMD03



.223/5.56 | 1/2"X28
■ / TLUMD01



.223/5.56 | 1/2"X28
■ / TLUMD02

AR15 MICRO GAS BLOCK

- » Low Profile, Fits Underneath Most Free Float Handguards
- » Precision Machined Steel to Exacting Tolerances for .750" Diameter Barrels at the Gas Port
- » Durable and Corrosion Resistant Manganese Phosphate Finish
- » Includes Gas Tube Roll Pin, Serrated Self-locking Set Screws, and Installation Tool

■ / MNT-ARMGB01



AR15 BLANK FIRING ADAPTOR

- » Precision Machined High Strength Steel Construction
- » Color Coated for Protection and Discernibility
- » Reinforced Frame Surpasses Military Standards
- » Ideal for Law Enforcement and Military Training
- » User Friendly Bolt Ring for Simple Installation and Removal

■ / MNT-16AD2-C



QD SLING SWIVELS & ADAPTORS



PICATINNY SLING SWIVEL MOUNT WITH 1.25" LOOP

- » Precision Machined Aircraft Aluminum and Steel Construction with a Matte Black Finish
- » Solid Steel 1.25" Sling Loop Compatible with Most Slings on the Market

■ / TL-SWMTPO1



ANGLED QD SLING SWIVEL PICATINNY ADAPTOR

- » Accepts Any Standard Quick Detach Sling Swivel with 0.37" Diameter Swivel Stud
- » Precision Machined from Aircraft Aluminum with a Matte Black Finish
- » Low Profile and Lightweight Design with 45° Offset
- » Designed with Quarter-turn Rotational Over Travel Stops to Restrict Swivel Movement

■ / TL-SWPM01



KEYMOD QD SLING SWIVEL ADAPTOR

- » Compact, Lightweight, Super Low Profile Keymod Base
- » Accepts Any Standard Quick Detach Sling Swivel with 0.37" Diameter Swivel Stud
- » Precision Machined from Aircraft Aluminum with a Matte Black Finish

■ / TL-SWKMO1



SLING SWIVEL ADAPTORS

- » Precision Machined from 6061-T6 Aircraft Aluminum with a Matte Black Anodization
- » Accepts Any Standard Quick Detach Sling Swivel with 0.37" Diameter Swivel Stud
- » Designed with Quarter Turn Rotational Over Travel Stops to Restrict Swivel Movement

■ / M-LOK® / TLUSW001
■ / Keymod / TLUSW002



AR15 QD RECEIVER END PLATE

- » Compatible with Standard Mil-spec AR15 Lower Receiver
- » Solid Steel Construction with a Matte Black Finish
- » Accepts Any Standard Quick Detach Sling Swivel with 0.37" Diameter Swivel Stud
- » Designed with Quarter Turn Rotational Over Travel Stops to Restrict Swivel Movement

■ / TL-T6TD03



PICATINNY/KEYMOD QD SLING SWIVEL ADAPTOR

- » Innovative, Compact, and Lightweight Design Adaptable for Installation on Both Picatinny or Keymod Rails
- » Accepts Any Standard Quick Detach Sling Swivel with 0.37" Diameter Swivel Stud
- » Precision Machined from Aircraft Aluminum with a Matte Black Finish

■ / TL-SWPK01

STEEL QD SLING SWIVELS

High Strength Steel Construction with a Matte Black Finish



1.09" LOOP
TL-QDSW08A



1.25" LOOP
TL-QDSW08B



1.29" C-SHAPE LOOP
TL-QDSW08C



1.38" LOOP
TL-QDSW18



1.41" LOOP
TL-QDSW38

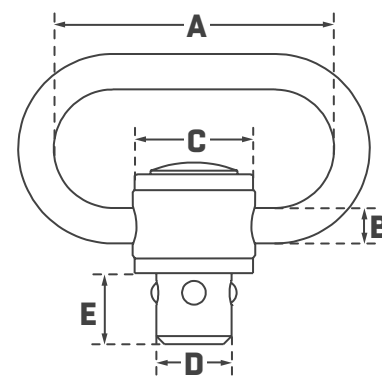

	1.09" LOOP TL-QDSW08A	1.25" LOOP TL-QDSW08B	1.29" C-SHAPE LOOP TL-QDSW08C	1.38" LOOP TL-QDSW18	1.41" LOOP TL-QDSW38
A-Loop Width	1.09"	1.25"	1.29"	1.38"	1.41"
B-Loop Thickness	0.13"	0.13"	0.13"	0.17"	0.18"
C- Push Button Diameter	0.47"	0.47"	0.47"	0.60"	0.64"
D-Stud Diameter	0.37"	0.37"	0.37"	0.37"	0.37"
E-Stud Height	0.35"	0.35"	0.35"	0.37"	0.35"

RAIL SECTIONS & COVERS



M-LOK® ANGLED PICATINNY MOUNT

- » Angled Offset Optimally Positions Lights, Optics, or Other Accessories at the 11 or 1 O'clock Positions on Most Handguards
- » Durable Matte Black Anodized Aluminum Construction
- » Removable Spacer Adjusts Clearance to Fit Various Handguard Profiles

■ / MT-MP45



LOW PROFILE M-LOK® RAIL PANEL COVER

- » 3.15" in Length, Slim, Lightweight, and Securely Installs via Two M-LOK® Screws and Nuts
- » Unique Aggressive Non-slip Textured Design Provides a Sure Grip Every Time
- » Molded from Durable Impact and Heat Resistant Polymer with a Rubberized Overmold for Added Grip Traction

■ / RB-HP30M (Set of 4)

G36 PICATINNY RAIL SETS



Two 3.87" Length Rails with 7 Picatinny Slots
■ / MNT-P501 (Set of 2)



One 6.08" Length Rail with 13 Picatinny Slots and Two 3.87" Length Rails with 7 Picatinny Slots
■ / MNT-P503 (Set of 3)



Three 6.08" Length Rails with 13 Picatinny Slots
■ / MNT-P505 (Set of 3)

UTG PRO® M-LOK® PICATINNY RAIL SECTIONS



3-slot / MTURS10S



7-slot / MTURS10M



4-slot / MTURS09S



8-slot / MTURS09M

TOOLS & MAINTENANCE



AR15/AR308 ARMORER'S MULTI-FUNCTION COMBO WRENCH

- » Provides the Tools to Install and Remove Parts Often Replaced and or Reinstalled on Both the AR15 and AR308 Platforms such as: Standard A2 Flash Hider, Delta Ring Assembly, Rifle Length Buffer Tube, Carbine Buffer Tube Castle Nut, and More
- » Steel Construction with Wear Resistant Finish for Long Lasting Durability

■ / TL-ARWR01



MINI AR15 ARMORER'S WRENCH

- » Provides the Tools to Install and Remove Parts Often Replaced and or Reinstalled on the AR15 Platforms such as: Standard A2 Flash Hider, Delta Ring Barrel Nut Assembly, Rifle Length Buffer Tube, Carbine Buffer Tube Castle Nut, and More
- » Steel Construction with Wear Resistant Finish for Long Lasting Durability

■ / TL-ARWR02



.223/5.56 CLEANING KIT

- » Includes a 5-piece Extension Steel Cleaning Rod with Adaptor, Patch Loop, Bronze Bore Brush, Chamber Brush, Double-Ended Nylon Utility Brush, ½ oz Oil Bottle, and Cleaning Patches
- » All Parts Conveniently Store within the Included OD Green Nylon Pouch with Belt Loop and ALICE Clip Attachment Point and Featuring Two Hook-and-loop Closure Pockets and External Snap Button Flap

■ / TL-A041



9 MM PISTOL CLEANING KIT

- » Conveniently Stows Away in Any Range Bag in Its Compact Polymer Case (4.63"x2.88"x1.50")
- » Kit Includes an 8-32 Threaded Copper Alloy Cleaning Rod with the Following Threaded Cleaning Accessories: Patch Loop, Bronze and Nylon Brush, and a Cotton Mop

■ / TL-CLP9MMKT



CHAMBER SAFETY FLAG

- » Bright Red for High Visibility and Reliable Confirmation of an Unloaded Firearm
- » Molded from Impact Resistant Polymer with Reinforced Head for Maximum Durability
- » Ideal for Cold Range Use and Mass Produced Firearms

■ / RB-CSF06 (Set of 6)



AK/SKS FRONT SIGHT TOOL

- » An Essential Tool for Making Fine Front Sight Post Windage and Elevation Adjustments
- » Compatible with AK, SKS, MAK, and SLR95 Pattern Rifles

■ / SCP-WEA05



UNIVERSAL SHOTGUN FOREND WRENCH

- » Nickel Plated Steel Construction
- » User Friendly with Ergonomic Handles for Easy Forend Removal and Installation
- » Compatible with REMINGTON® 870™, MOSSBERG® 500A/C, 835, and Other Clones

■ / TL-SHWR01

GUN CASES

BRING MORE THAN ONE GUN.

As expected and in typical fashion, we have all set a good example and simply bought both. Now zip up those cases, square away the ammo, and don't forget the magazines. Transport your range toys and your work horses with Leapers.



JUMP TO A SERIES

RAPID DEPLOYMENT PACKS	168
Responder Sling Pack 34"	
Rapid Sling Packs 30" / 34"	
RC CASE	170
42"	
MC CASE	172
34" / 32" / 25"	
DC CASE	174
42" / 38" / 34"	
KEEP-IT-SIMPLE KIS CASE	176
38" / 28"	
PISTOL CASES	178
Competition Shooter's Double Pistol Case	
Double Pistol Case	
Single Pistol Case	
Discreet Handgun Case	

(THIRD PARTY TRADEMARKS MAY BE USED IN THIS CATALOG FOR USER CONVENIENCE TO INDICATE THE FIT OR COMPATIBILITY OF THE APPLICABLE PRODUCT.)





RAPID DEPLOYMENT PACKS



RESPONDER SLING PACK

- » Front Zipper Pocket Features MOLLE Webbing and Tool Pouch
- » Padded Barrel Catch Keeps Muzzle Secured and Protected During Transportation
- » Quick Deployment Pull Tab for Rapid Deployment
- » Padded Back Panel for Comfortable Carry and Back Support
- » Dual #10 Lockable Zippers

■ / 34 inch / PVC-PSP34B



RAPID SLING PACKS

- » Discreet Overall Shape and Appearance
- » Padded Barrel Catch Keeps Muzzle Secured and Protected During Transportation
- » Features Top and Bottom Wraparound Carry Handles and Quick Deployment Pull Tabs
- » Dual #10 Lockable Zippers
- » Removable Padded Center Divider Separates and Protects Firearms when Transporting Two Together

■ / 34 inch / PVC-PSP34BX ■ / 30 inch / PVC-PSP30BN
 ■ / 34 inch / PVC-PSP34BN
 ■ / 34 inch / PVC-PSP34BG



Black ■	PVC-PSP34B	PVC-PSP34BX	
Black / Navy ■		PVC-PSP34BN	PVC-PSP30BN
Black / Gray ■		PVC-PSP34BG	
Main Compartment Dimensions	34" x 15"	34" x 13"	30" x 12"
Material	Polyester	Polyester	Polyester
Density	1200D	900D	900D

RC CASE



OPERATIONS RC GUN CASE

- » Three Front Detachable MOLLE Pouches Perfect for Magazines, Ammo, and Other Shooting Gear
- » Inner Hook-and-loop Pockets can Store Pistol, Cleaning Equipment, and Targets
- » Secondary Compartment Contains Additional MOLLE Webbing
- » Removable Padded Center Divider
- » Fully Adjustable Hook-and-loop Retention Straps and Padded Corner Pockets
- » Rigid Back Spine for Improved Durability and Shape Integrity
- » Dual #10 Lockable Zippers

■ / 42 inch / PVC-RC42B-A

Black ■	PVC-RC42B-A
Main Compartment Dimensions	42" x 13"
Material	Polyester
Density	900D



HOMELAND SECURITY MC GUN CASES



25 INCH CASE



32/34 INCH CASES



25 INCH CASE



32 INCH CASE





34 INCH CASE



HOMELAND SECURITY MC GUN CASES

- » Durable 600D Polyester Construction
- » Padded Main Compartment with User Configurable Retention Straps
- » Outer Compartment Stores Other Essential Gear and Ammunition
- » Features D-ring Wall Hanger, Carry Handle, Adjustable Shoulder Strap, Morale Patch Panel, and Dual #10 Lockable Zipper Closures

-  / 34 inch / PVC-MC34B-A
-  / 32 inch / PVC-MC32B-A
-  / 25 inch / PVC-MC25B-A

	Black 	PVC-MC34B-A	PVC-MC32B-A	PVC-MC25B-A
Main Compartment Dimensions		34" x 12"	32" x 12"	25" x 12"
Material		Polyester	Polyester	Polyester
Density		600D	600D	600D

DELUXE DC GUN CASES



42 INCH CASE



38 INCH CASE



34 INCH CASE

DELUXE DC GUN CASES

- » 5 Magazine Pouches with Hook-and-loop Closures and D-ring Pulls
- » Rigid Back Spine for Improved Durability and Shape Integrity
- » Padded Interior Provides Maximum Protection from Dents and Scratches
- » Two-piece Wraparound Carry Handle
- » Adjustable Shoulder Strap
- » Dual #10 Lockable Zippers

- / 42 inch / PVC-DC42B-A
- / 38 inch / PVC-DC38B-A
- / 34 inch / PVC-DC34B-A

	Black ■	PVC-DC42B-A	PVC-DC38B-A	PVC-DC34B-A
Main Compartment Dimensions		42" x 13"	38" x 12.5"	34" x 12"
Material		Polyester	Polyester	Polyester
Density		900D	900D	900D



KEEP-IT-SIMPLE

KIS GUN CASES | KEEP-IT-SIMPLE



38 INCH CASE



28 INCH CASE

KIS GUN CASES | KEEP-IT-SIMPLE

- » Two Zippered Outer Pockets Store Other Essential Gear, Ammunition, and Paper Targets
- » Features Wall Hanger Loops, Carry Handle, Adjustable Shoulder Strap, Morale Patch Panel
- » Dual #8 Lockable Zippers

- / 38 inch / PVC-KIS38B2
- / 28 inch / PVC-KIS28B

Black ■	PVC-KIS38B2	PVC-KIS28B
Main Compartment Dimensions	38" x 11"	28" x 12.5"
Material	Polyester	Polyester
Density	600D	600D





PISTOL CASES



COMPETITION SHOOTER'S DOUBLE PISTOL CASE

- » Inside Large Hook-and-loop Panel Complete with 2 Universal Detachable Holsters, Plus Elastic Loops for Magazines
- » Padded Center Pouch Provides Pockets of Various Sizes to Store Various Shooting Essentials
- » Exterior Equipped with Two Miscellaneous Pockets with Zippered Closures
- » Additional Hook-and-loop Panel for Attaching Patches
- » Elastic Bands for Pistol Magazines, Flashlights, Suppressors, and Other Equipment
- » Padded Center Pouch Provides Pockets to Store Additional Accessories and Ammunition
- » Dual #8 Lockable Zippers

■ / 11.5 x 9.5 inch / PVC-PC05B



DOUBLE PISTOL CASE

- » Fully Padded Interior
- » 6 Universal Magazine Pouches
- » Additional Outer Accessory Pocket
- » Wraparound Carry Handles
- » Dual #10 Lockable Zippers

■ / 13 x 10 inch / PVC-PC02B

SINGLE PISTOL CASE

- » Fully Padded Interior
- » 5 Universal Magazine Pouches
- » Additional Outer Accessory Pocket
- » Wraparound Carry Handles
- » Dual #10 Lockable Zippers

■ / 11 x 8 inch / PVC-PC01B

DISCREET HANDGUN CASE

- » Universal Design Compatible with Most Sub-compact Pistols or Revolvers
- » Padded Construction with Reinforced Double Stitching for Added Durability
- » Integral Spare Magazine Pouch
- » Supported Front and Back Panels for Improved Durability and Shape Integrity
- » Dual #8 Lockable Zippers

■ / 5 x 7 inch / PVC-PC380

Color	PVC-PC05B	PVC-PC02B	PVC-PC01B	PVC-PC380
Black ■				
Main Compartment Dimensions	11.5" x 9.5"	13" x 10"	11" x 8"	5" x 7"
Material	Polyester	Polyester	Polyester	Polyester
Density	900D	1680D	1680D	1680D

TACTICAL GEAR

PREP FOR ANYTHING.

Victory loves preparation. Plan ahead and get your gear in check with Leapers. Whether heading to an after work range session, spending the weekend outdoors, or its open season spend more time enjoying it and less time hassling around at the last minute.

JUMP TO A SERIES

TRAIL SEEKER, TRAIL CAM BACKPACK	182
OVERBOUND PACK	184
ALL-IN-ONE RANGE/UTILITY GO BAG	186
HOLSTERS	188
Universal Ankle Holster	
Belt Holster	
Ambidextrous Belt Holster	
Concealed Belt Holster	
Elite Tactical Thigh Holster	
Special OPS Tactical Tight Holster	
Horizontal Shoulder Holster	
Vertical Shoulder Holster	
LONG GUN SLINGS & BELT	190
TACTICAL VESTS	191

(THIRD PARTY TRADEMARKS MAY BE USED IN THIS CATALOG FOR USER CONVENIENCE TO INDICATE THE FIT OR COMPATIBILITY OF THE APPLICABLE PRODUCT.)



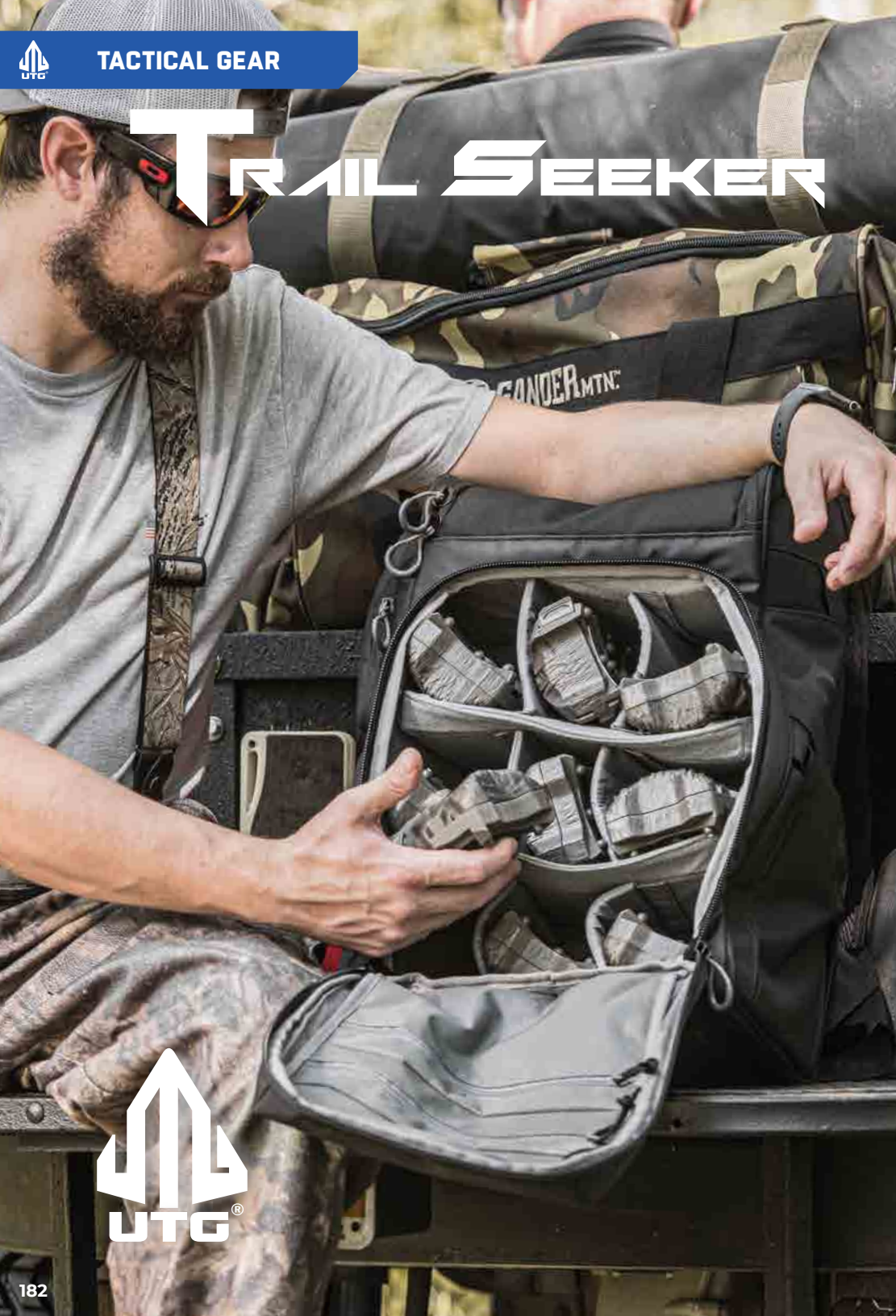

TRAIL SEEKER

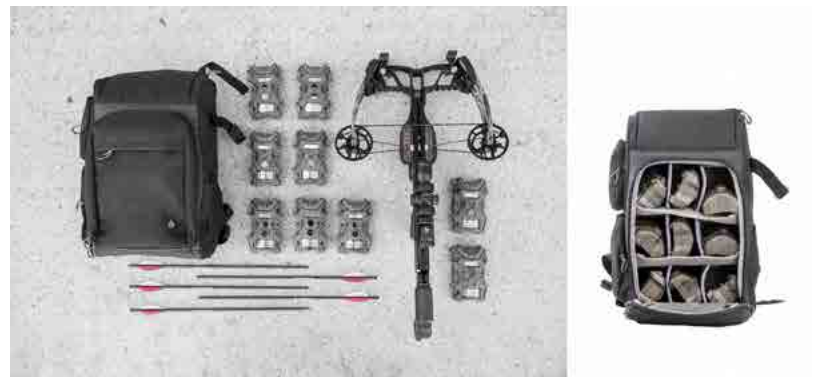

TRAIL SEEKER, TRAIL CAM BACKPACK



- » Padded Modular Main Compartment with User-configurable Hook-and-loop Dividers and Shelf Inserts
- » 28 Liter Total Compartmental Capacity Easily Stores Up to 9 Trail Cams



- » Removable SD Card Holder Included and Holds up to 24 SD Cards



- » Miscellaneous Pouches, Elastic Loops, and Zippered Pockets Provide Ample Storage Space for Other Related Accessories
- » Spiked Rubber Bottom



- » Comfortable and Wearable Ergonomics Include Breathable Padded and Moisture Wicking Back Panel and Shoulder Straps
- » Adjustable Chest and Waist Straps for Added Close Body Retention when on the Move

TRAIL SEEKER, TRAIL CAM BACKPACK

- » Durable Water-resistant 600D Polyester Construction with Reinforced Heavy Gauge Stitching and Spiked Rubber Bottom
- » Padded Modular Main Compartment with User-configurable Hook-and-loop Dividers and Shelf Inserts
- » 28 Liter Total Compartmental Capacity Easily Stores Up to 9 Trail Cams
- » Miscellaneous Pouches, Elastic Loops, and Zippered Pockets Provide Ample Storage Space for Other Related Accessories

■ / PVC-GC01

Color	Black ■	PVC-GC01
Dimensions		14" x 9" x 19"
Material		Polyester
Density		600D
Capacity		28 Liter



OVERBOUND PACK

OVERBOUND PACK



OVERBOUND PACK

- » Durable 600D Nylon Construction with Reinforced Heavy Gauge Stitching
- » Optimized Space Saving Compartments, Pockets, and Layout Gets You to the Things You Need
- » Modular Outer MOLLE and Hook-and-loop Panels for Attaching Other Gear and Morale Patches
- » Rear Back Panel Compartment Easily Accessible from the Left or Right Side for Quick Storage and Use Items

■ / PVC-P836GM



Ergonomic, Contoured and Padded Shoulder Straps



Luggage Strap

Gun Metal ■	PVC-P836GM
Dimensions	12" x 6" x 18"
Material	Nylon
Density	600D
Capacity	28 Liter



ALL-IN-ONE RANGE BAG



ALL-IN-ONE RANGE BAG



8 Removable, Thickly Padded, and Adjustable Internal Dividers, 2 Removable Pistol Cases, and 1 Brass Bag Included



Open Top with Clear Zippered Pocket, Lockable Zipper Closure for Full and Easy Access to Main Compartment



Zippered Side Pocket and Retention Adjustable Water Bottle Pouch



Thickly Padded Bottom with Four Rubber Foot Pads Prevent the Bottom of the Bag from Abrasion



Removable Pistol Cases, and Brass Bag included; Perfect for Competition and Recreation

ALL-IN-ONE RANGE/UTILITY GO BAG

- » Tough PVC Coated Material, Reinforced Stitching, Heavy Duty Zippers, and Padded Pockets
- » Ample Storage Capacity and Layout Designed to Meet Different Application Demands for Simple Organization
- » Zippered Side Pocket for Ammunition, Magazines, and Other Accessories via 8 Elastic Loops
- » Padded Front and Back Zipper Pockets with MOLLE Webbing
- » Fully Adjustable Shoulder Strap and Wraparound Carry Handles

■ / PVC-P365B

Color	Black ■	Model	PVC-P365B
Dimensions	21" x 9" x 8"		
Material	Polyester		
Density	600D		



HOLSTERS



- » Adjustable Hook-and-loop Calf and Ankle Straps
- » 11.5" Overall Height with Adjustable Ankle Circumference from 11.5" - 15.5"
- » Calf Circumference from 11.5" - 19"

- » Position Adjustable Retention Strap



- » Padded, Breathable, and Reinforced Neoprene Construction

UNIVERSAL ANKLE HOLSTER

- » Universal and Ambidextrous
- » Position Adjustable Retention Strap, Extended Muzzle Guard, and Formfitting Dual layer Elastics for Greater Compatibility Across Most J-frame, Subcompact, and Compact Pistols
- » Synthetic Panel Overlay Guards Against Compression and Unwanted Ingress into the Trigger Guard

■ / Ambidextrous / PVC-H191B



BELT HOLSTER

- » Designed to Fit most Compact to Full Size Pistols
- » Adjustable Holster Strap Retention with Quick Release Buckle
- » Built-in Magazine Pouch
- » Durable Hook-and-loop Belt Retention Strap

■ / Right Handed / PVC-H270B



AMBIDEXTROUS BELT HOLSTER

- » Universal Design with Open Bottom to Fit a Wider Variety of Compact to Full Size Pistols
- » Adjustable Hook-and-loop and Snap-on Thumb Break Retention Strap

■ / Ambidextrous / PVC-H288B



CONCEALED BELT HOLSTER

- » Ideally Fits Most Sub-Compact Pistols
- » Right Handed, Inside the Waistband (IWB) Carry
- » Thickly Padded for Comfortable Carry
- » Low Profile Elastic and Hook-and-loop Closure for Secure Retention

■ / Right Handed / PVC-H388B



ELITE TACTICAL THIGH HOLSTER

- » Fits Most Compact to Full Size Pistols
- » Durable Composite Padding with Heavy Duty Quick Release Buckle System
- » Height Adjustable Belt Strap
- » Adjustable Holster Retention

■ / Right Handed / PVC-H168ET



Hook-and-loop Strap Pulls Holster Towards Thigh for a Close-to-body Fit

SPECIAL OPS TACTICAL THIGH HOLSTERS

- » Fits Most Compact to Full Size Pistols
- » Fully Adjustable Nonslip Leg Strap with Buckle Closure and Cushioned Wraparound Main Body
- » Height Adjustable Belt Strap with Buckle Closure
- » Adjustable Thumb Strap Retention with Quick Release Buckle
- » Built-in Spare Magazine Pouch

■ / Right Handed / PVC-H178B
 ■ / Left Handed / PVC-H178BL



SHOULDER HOLSTERS

- » Universal Fit Compatible with Most Compact to Full Size Pistols
- » Fully Adjustable Design Fits Most Body Types
- » Reinforced Stitching and Seams
- » Inverted Dual Magazine Pouch with Hook-and-loop Closures

■ / Horizontal / Ambidextrous / PVC-H170B
 ■ / Vertical / Ambidextrous / PVC-H175B



LONG GUN SLINGS & BELT



BOLLA® 2 TO 1 POINT CONVERSION QD SLING

- » Adjustable in Length from 42"-58", Matte Black 1.2" Width Polyester Webbing with Portion of Sling Padded for Comfort
- » Lightweight Steel Slider with Oversized D-ring and Pull Strap Intuitively and Quickly Adjusts Sling Tension by Pulling Forward to Increase Slack and Length and Rearward to Decrease Slack and Length
- » Steel QD Sling Swivels and an Ambi. QD Swivel Housing Easily Converts the Sling from 2 Point to 1 Point Configuration

■ / Two to One Point / PVC-GB508B



QD SLING SWIVEL SINGLE POINT BUNGEE SLING

- » Heavy Duty 1.5" Quick Adjustable Polyester Webbing and Elastic Construction
- » Steel Push Button Quick Detach Sling Swivel Attachment for Quick Installation and Removal
- » Durable Bungee System Reduces Fatigue by Relieving the Felt Weight of the Firearm from the User's Shoulder
- » Inner Length Adjustable from 42" to 58" to Accommodate Various Body Types and Gear

■ / Single Point / PVC-GB507B



UNIVERSAL RIFLE SLING

- » Durable 1.5" Width Webbing with Nonslip Grip Texture Applied to Keep Sling from Unintentionally Shifting
- » Traditional Sling Loops Securely Fasten to a Wide Variety of Different Firearms
- » Adjustable Length from 44" to 52" to Accommodate Various Body Types and Gear

■ / Two Point / PVC-GB605



LAW ENFORCEMENT & SECURITY DUTY BELT

- » Detachable Belt Keepers
- » Hook-and-Loop Adjustment (30" - 52" Waist)
- » Two Horizontal Pistol Magazine Pouches
- » Heavy Duty Quick Release Buckle

■ / PVC-B950-A

547 LE TACTICAL VESTS



547 LE TACTICAL VESTS

- » Breathable Materials & Construction Releases Moisture and Heat
- » Padded Shoulder Pad and Guard Absorbs Recoil and Aids in Consistent Stock Placement
- » Large ID Pouch with Detachable Elastic Shot Shell Carrier
- » Dedicated Communication Pouch
- » 3 Double Stack Pistol Magazine Pouches and 2 Detachable Horizontal Magazine Pouches
- » Single Quick Reload Rifle Magazine Pouch
- » Detachable Right-handed Cross-draw Holster Interchangeable with Included Double Rifle Magazine Pouch
- » Reinforced Drag Handle
- » Heavy Duty Back Panel Webbing for Attaching Additional Gear
- » One Size Fits Most with Straps Adjustable in Girth up to a 54" Waist

■ / Right Handed / PVC-V547BT

■ / Left Handed / PVC-V547BL

	Black ■	PVC-V547BT	PVC-V547BL
Adjustable Height		22" - 25"	22" - 25"
Adjustable Girth		40" - 54"	40" - 54"
Adjustable Belt Length		44" - 52"	44" - 52"
Material		Polyester	Polyester
Density		1680D	1680D
Handedness		Right Handed	Left Handed

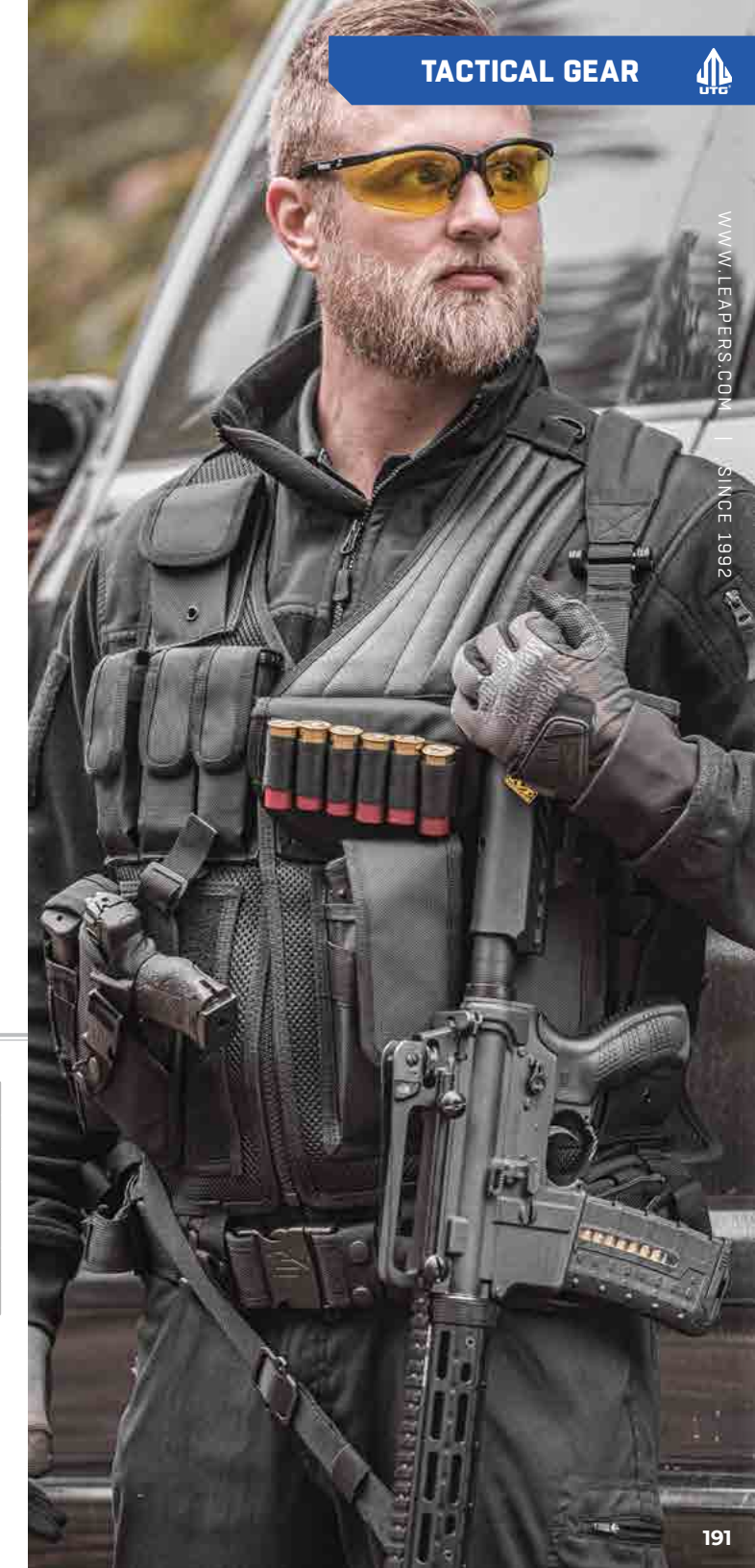

INDEX

(THIRD PARTY TRADEMARKS MAY BE USED IN THIS CATALOG FOR USER CONVENIENCE TO INDICATE THE FIT OR COMPATIBILITY OF THE APPLICABLE PRODUCT.)

A

AIR11834	073
AIR11834AB	073
AIR11834AR	073
AIR11834Q	073
AIR11850	073
AIR11850AR	073
AIR11850Q	073
AIR12234	073
AIR12234AB	073
AIR12234AR	073
AIR12250	073
AIR12250AB	073
AIR12250AR	073
AIR12250Q	073
AIR122S	073
AIR122SAB	073
AIR31834	073
AIR31834AB	073
AIR31834AR	073
AIR31850	073
AIR31850AB	073
AIR31850AR	073
AIR32234	073
AIR32234AR	073
AIR32234Q	073
AIR32250	073
AIR32250AB	073
AIR32250Q	073
AIR322S	073
AIR322SAR	073
AIR42250	073
AIR42250AB	073
AIR42270Q	073
AIR422S	073
AIR422SAR	073
AQR110	071
AQR115	071
AQR120	071

AQR310	071
AQR315	071
AQR322	071
AQR415	071
AQR420	071
AQR422	071
AQR432	071
AS303FA2	033
AS403FA2	035
AS601FA1	031
AS601FB1	031

F

FCR001	099
FCR002	097
FLR001	099
FLR002	097
FUR001	097
FUR001	099

I

IX403FA2	021
IX602FA2	023
IX603FA2	023
IX645FM1	025
IX645FM2	025
IX645FM3	025
IX801FA1	019
LT-EL700	154
LT-ELEDC01	154
LT-ELP120R	155
LT-ELP123R-A	155

M

MNT-16AD2-C	162
MNT-755	089
MNT-757	089
MNT-955	089
MNT-957	089

MNT-993	091
MNT-ARMGB01	162
MNT-DG02Q	126
MNT-DG02Q	141
MNT-DNT06	076
MNT-DT2PW01	076
MNT-DTW145	076
MNT-EL228GPQ-A	155
MNT-GRP002SQ	141
MNT-MB500T	077
MNT-P501	164
MNT-P503	164
MNT-P505	164
MNT-PMTOWL-A	076
MNT-RM700	077
MNT-RM700S	077

AS303FA2	033
AS403FA2	035
AS601FA1	031
AS601FB1	031

MT-745	089
MT-750X	091
MT-754X	091
MT-945	089
MT-950RS03	091
MT-950X	090
MT-AFGK01	142
MT-AFGK01B	142
MT-AFGK01R	142
MT-AFGM01	142
MT-AFGM01B	142
MT-AFGM01R	142
MT-AFGP01	142
MT-EL223GX	155
MT-FGK01	141
MT-FGM01	141
MT-FGM01X	141
MT-FGP01	141
MT-FGP01X	141
MT-FG590	077
MT-MB590M	077
MT-MP45	164
MT-MR013C	081
MT-MR0AC	081
MT-MROXS	081
MT-RM870	077
MT-RMR13C	081
MT-RMR45	105
MT-RMRAC	103
MT-RMRGL	103
MT-RMRKIT	105
MT-RMRXS	103

MT-RSX1L	083
MT-RSX1S	083
MT-RSX20MOA	083
MT-RSX5L	083
MT-RSX5S	083
MT-RSX7L	083
MT-RSX7S	083
MT-RSX8L	083
MT-RSX8S	083
MT-RTF1	072
MT-RTF3	072
MT-RTF4	072
MT-RTR1	072
MT-RTR3	072
MT-RTR4	072
MT-T113C	081
MT-TIAC	081

MTU001	111
MTU001SSM	111
MTU001T	111
MTU006SSM	109
MTU007	111
MTU009	113
MTU011	113
MTU015SSM	111
MTU016	082
MTU019SSM	109
MTU019SSM3	109
MTU019SSM3B2	109
MTU019SSM3R2	109
MTU019SSMB2	109
MTU019SSMD	109
MTU019SSMR2	109
MTU019SSMZ2	109
MTU028SG	077
MTU029SG	077
MTU030T22	077
MTU044SEM	105
MTU044SPM	103
MTU044XLM	107
MTU045SEM	105
MTU045SPM	103
MTU045XLM	107
MTU046SEM	105
MTU046SPM	103
MTU046XLM	107
MTU047SEM	105
MTU047SPM	103

MTU047XLM	107
MTU048SEM	105
MTU048SPM	103
MTU049SEM	105
MTU049SPM	103
MTU050SSM	113
MTU052	113
MTU053SSM	112
MT-UAK01	082
MTURS09M	164
MTURS09S	164
MTURS10M	164
MTURS10S	164
MT-ZAK01	082

O

OP3-G1563CRWQ	049
OP3-GM3124UMOA	043
OP3-GM4164UMOA	043
OP3-SW080	043
OP-DS2018R	059
OP-DS2521R	059
OP-RDM20CT	063
OP-RDM20CTS	063
OP-RDM20G	063
OP-RDM20R	063
OP-RMR20CTS	063
OP-RMR20R	063
OPUMR01	061
OT-RDM16R	062

P

PVC-B950-A	190
PVC-DC34B-A	175
PVC-DC38B-A	175
PVC-DC42B-A	175
PVC-GB507B	190
PVC-GB508B	190
PVC-GB605	190
PVC-GC01	183
PVC-H168ET	189
PVC-H170B	189
PVC-H175B	189
PVC-H178B	189
PVC-H178BL	189
PVC-H191B	188
PVC-H270B	188
PVC-H288B	188
PVC-H388B	188

PVC-KIS28B	177
PVC-KIS38B2	177
PVC-MC25B-A	173
PVC-MC32B-A	173
PVC-MC34B-A	173
PVC-P365B	187
PVC-P836GM	185
PVC-PC01B	179
PVC-PC02B	179
PVC-PC05B	179
PVC-PC380	179
PVC-PSP30BN	169
PVC-PSP34B	169
PVC-PSP34BG	169
PVC-PSP34BN	169
PVC-PSP34BX	169
PVC-RC42B-A	171
PVC-V547BL	191
PVC-V547BT	191

R

RB-CSF06	165
RB-FGM01	141
RB-HP30M	164
RB-T308FB	135
RB-T469B	135
RB-T6BFH2	137
RB-T6BFH3	137
RBT-AKM30	147
RBT-AM10	149
RBT-AM30	149
RBT-APG01B	140
RBT-DM25	149
RBT-GL915	151
RBT-GL917	151
RBT-GL933	151
RBT-PD933	151
RBT-TKSDC	160
RBU47FS01	131
RBU6BM	133
RBU6DM	133
RBUAM01	149
RBUPG01B	140
RBUPG01D	140
RBUS1BM	133
RBUS1BMS	133
RBUS1DM	133
RBUS1DMS	133
RBUS2BM	133

RBUS2BMS	133
RBUS2DM	133
RBUS2DMS	133
RBUS3BM	133
RBUS3BMS	133
RBUS3DM	133
RBUS3DMS	133
RBUS4BM	133
RBUS4BMS	133
RBUS4DM	133
RBUS4DMS	133
RBUS5BMS-A	135
RDM-2045	079
RDM-20AC	079
RDM-20GL	079
RDM-20SIG	079
RDM-20SW	079
RDM-20XSD	079
RDU012515	069
RDU012520	069
RDU013010	069
RDU013015	069
RDU013022	069
RG2W1104	075
RG2W1154	075
RG2W1204	075
RG2W3104	075
RG2W3154	075
RG2W3224	075
RG-FL138	157
RG-FL27KC	157
RG-FL27MC	157
RGPM-25H4	075
RGPM-25M4	075
RGPM2PA-25H4	075
RGPM2PA-25M4	075
RGPM2PA-30H4	075
RGPM2PA-30M4	075
RGPM-30H4	075
RGPM-30M4	075
RGPMOFS38-25H4	075
RGWM-25H4	075
RGWM-25L2	075
RGWM-25M4	075
RGWM-30H4	075
RGWM-30L4	075
RGWM-30M4	075
RWU012510	069

S

SCP-27PRGW	051
SCP3-18IEBG4	041
SCP3-274LA0IEW	051
SCP3-U312A0IEW	041
SCP3-U416A0IEW	041
SCP3-UM312A0IEW	041
SCP3-UM416A0IEW	041
SCP-DS3026W	065
SCP-DS3039W	065
SCP-DS3840TDQ	065
SCP-DS3840W	065
SCP-ES403	041
SCP-ES403	047
SCP-LS200	157
SCP-LS268	157
SCP-LS279S-A	157
SCP-LS289S	156
SCP-M312A0D	045
SCP-M312A0WQ	045
SCP-M392A0IEWQ	045
SCP-M392A0LWQ	045
SCP-M4CR5WQ	049
SCP-MF3WEQS	065
SCP-RD40RGW-A	065
SCP-RG40CDQ	065
SCP-RG40SDQ	065
SCP-SW060B	041
SCP-SW080B	041
SCP-SW080BB	045
SCP-SW100B	041
SCP-TDTDQ	065
SCP-U394A0IED	047
SCP-U394A0IEW	047
SCP-U4164A0IEW	047
SCP-U432FD	047
SCP-U6245A0IEW	047
SCP-WEA05	165

T

TL-A041	165
---------	-----

TL-ARWR01	165
TL-ARWR02	165
TL-BP01-A	125
TL-BP02-A	125
TL-BP03-A	125
TL-BP20Q-A	127
TL-BP78	127
TL-BP78Q	127
TL-BP88	127
TL-BP88Q	127
TL-BP98Q	127
TL-BP99Q	127
TL-BPAD1	127
TL-BPDK01	123
TL-BPDK02	123
TL-BPDM01	123
TL-BPDM02	123
TL-BPDM03	123
TL-BPDM04	123
TL-BPFS01-A	119
TL-BPLE01	117
TL-BPLE01	127
TL-BPM01	125
TL-BPM02	125
TL-BPM03	125
TL-BP0B01-A	121
TL-CLP9MMKT	165
TL-HS02B	143
TL-HSK01	143
TL-HSK01B	143
TL-HSK01R	143
TL-HSM01	143
TL-HSM01B	143
TL-HSM01R	143
TL-M47SR	082
TL-QDSW08A	163
TL-QDSW08B	163
TL-QDSW08C	163
TL-QDSW18	163
TL-QDSW38	163
TL-SHWR01	165
TL-SWKM01	163
TL-SWMTPO1	163
TL-SWPK01	163
TL-SWPM01	163
TL-T6TD03	163
TLT-A2KT	137
TL-CSCH01	161

TLT-CSCH01B	161
TLT-CSCH01R	161
TLT-CSSLT01	161
TLT-CSSLT01B	161
TLT-CSSLT01R	161
TL-TRK01	143
TL-TRK01B	143
TL-TRK01R	143
TL-TRM01	143
TL-TRM01B	143
TL-TRM01R	143
TL-TKSO1	160
TLT-TKSBC	160
TLT-TKSLT	160
TLT-TKSLTB	160
TLT-TKSLTR	160
TLT-TKSMR	160
TLT-TKSMRR	160
TLT-TKSTG	160
TLT-TKSTGB	160
TLT-TKSTGR	160
TLU001	137
TLU001B	137
TLU001D	137
TLU001D-KIT	137
TLU001-KIT	137
TLU001MS	137
TLU001R	137
TLU001Z	137
TLU008	137
TLU008-KIT	137
TLU009	137
TLU009-KIT	137
TLUBP01	117
TLUBP01M	117
TLUBP02-A	117
TLUBP02M-A	117
TLUFS55	087
TLUFS56	087
TLUMD01	162
TLUMD02	162
TLUMD03	162
TLURS001	090
TLURS55	087
TLURS56	087
TLUSW001	163
TLUSW002	163

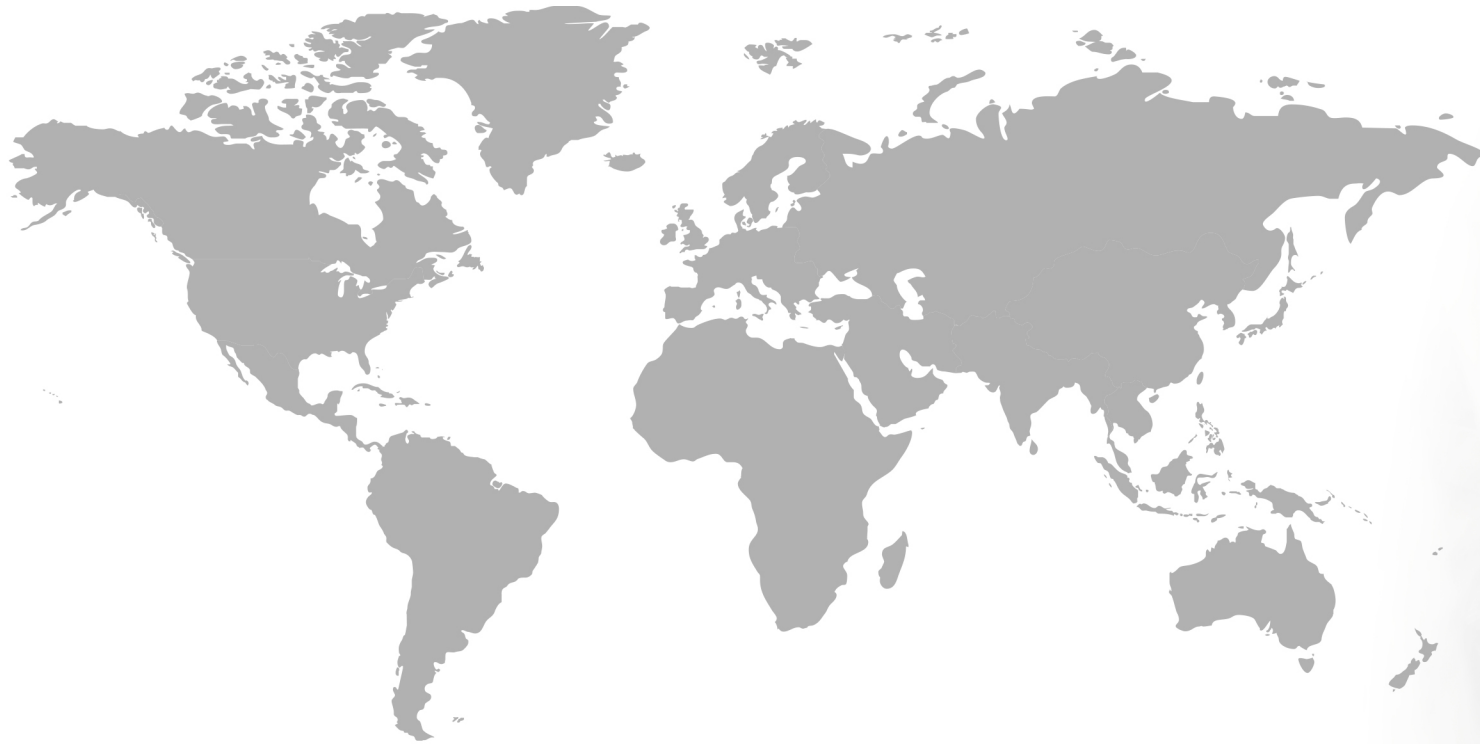

LEAPERS®

INTEGRIX™

ACCUSHOT PRO™

UTG PRO®

UTG®

USA HEADQUARTERS UTG PRO PLANT

ADDRESS 32700 CAPITOL STREET,
LIVONIA, MI 48150 U.S.A.
TELEPHONE (734) 542-1500
FAX (734) 542-7095
E-MAIL OFFICE@LEAPERS.COM
WEBSITE WWW.LEAPERS.COM

UTG EUROPE

AM BAHNDAMM 7,
63683 ORTENBERG, GERMANY
+49 (0) 6041-969686 0
+49 (0) 6041-969686 66
INFO@UTGEUROPE.COM
WWW.UTGEUROPE.COM

UTG CHINA

NO. 868 XINGYU ROAD,
NANTONG, JIANGSU, CHINA
+86 (0) 513 81503888
+86 (0) 513 81503588
OFFICE@LEAPERS.COM
WWW.UTG.COM.CN

UTG TAIWAN

NO.36, QUNYI RD., ZHUNAN TOWNSHIP,
MIAOLI COUNTY 350, TAIWAN (R.O.C.)
+886 (0) 37 580333
+886 (0) 37 580337
CONSEIL@UTG-TAIWAN.COM
WWW.UTGTAIWAN.COM

